

ABB MEASUREMENT & ANALYTICS | OPERATION INSTRUCTION

LMT Series

Magnetostrictive level transmitter
LMT100 & 200 models



High accuracy liquid level and
interface level detection

K-TEK Level products
Measurement made easy

Table of Contents

1	Introduction	5
	Product description	5
2	Safety	6
	General safety information.	6
	Improper use	6
	Technical limit values	6
	Warranty provision.	6
	Use of instruction	7
	Operator liability	7
	Qualified personnel	7
	Returning devices	7
	Disposal	7
	Information on WEEE Directive 2002/96/EC (Waste Electrical and Electronic Equipment).	7
	Safety information for electrical installation.	7
	Safety information for inspection and maintenance.	8
	Explosives atmospheres installation.	8
3	Transmitter Overview	9
	Transmitter components overview.	9
4	Unpacking.	10
	Identification	10
	Optional wired on SST plate	11
	Unpacking and Handling	11
	Transport and storage	11
5	Mounting	12
	General	12
	All installations.	12
	Hazardous area considerations	12
	IP Protection and Designation.	12
	Mounting the transmitters.	12
	Mounting an LMT100	12
	Mounting the LMT200	14
	LMT200 valve positioner	16
	Pressure Equipment Directive (PED) (97/23/CE)	17
	Transmitter housing rotation	17
	Installing / removing the external push buttons	17
	Installing / removing the HMI display	17
	Integral display rotation	17
	Securing the housing in flame-proof areas.	18

6	Transmitter wiring	19
	Cable connection	.19
	Supply requirement	.20
	Wiring procedure	.20
	Grounding	.21
	Integrated lightning protection	.21
7	Commissioning	22
	Transmitter factory configuration consideration	.22
	Preliminary checks prior to start-up	.22
	Local push buttons functionality	.22
	Write protection	.22
	Write protection activation via external push button	.22
	Write-protection via device software	.22
	Failure Mode	.23
	Activation via hardware switch	.23
	Failure mode via device software	.23
	Analog and HART communication models	.23
	Standard setting for error detection (alarm) 3.6 mA / 21 mA	.23
	Verify proper power-up of the transmitter	.23
	Range and span consideration	.23
	Factory settings	.24
	Configuration types	.24
	Configuring the transmitter without an integral HMI	.24
	Configuring the transmitter using the optional integral HMI - Through the Glass (TTG) (L2 option)	.24
	Commissioning using the Easy Setup Menu	.25
	Configuration with the PC/laptop	.26
	Configuration with a HART handheld terminal	.26
8	Operation	27
	Menu navigation	.27
	Control button functions	.27
	HMI menu structure	.27
	Easy Setup	.28
	Device Setup	.28
	Display	.28
	Process Alarm	.28
	Calibrate	.28
	Diagnostics	.28
	Device Info	.28
	Communication	.28
	Menu levels	.29
	Product display	.29
	Switching to operator menu	.30
	Switching to the configuration level parameter entry	.30

Selecting and changing parameters	31
Selecting a parameter value.	31
Setting a numerical parameter.	31
Exiting the setup.	31
Menu: Easy Setup.	31
Menu: Device Setup	34
Damping.	37
Overview of the linearization/strapping tables.	37
Menu: Display	43
Menu: Process Alarm.	45
Menu: Calibrate	47
Level Calibration	48
Menu: Diagnostics	52
Waveform display	55
Menu: Device Info.	59
Menu: Communication	61
9 Troubleshooting.	63
Error messages via HMI display and HART signal	63
Error states and alarms	63
10 Maintenance	66
Personnel qualifications	66
Required tools.	66
Electronic replacement	66
Safety Inspection and Test.	67
Float inspection.	67
Sensor inspection	68
Transmitter testing.	68
Output Checkout.	68
Spare parts	68
11 Dimensional drawings	69
12 ABB RMA Form	81

1 Introduction

This manual is designed to provide information on installing, operating and troubleshooting the LMT Series of level transmitters. This LMT Series is comprised of the LMT100 and LMT200 models.

Every section of this manual is dedicated to the specific phases of the LMT lifecycle. The start of the lifecycle begins with the receipt of the transmitter and its identification and continues through installation, the connection of all electrical components, the configuration of the device and finally ends with the troubleshooting and maintenance operations.

Product description

The LMT Series of level transmitters is a modular range of field mounted, microprocessor-based electronic transmitters, utilizing multiple sensor technologies. Accurate and reliable measurement of liquid levels is provided in even the most difficult and hazardous industrial environments. The LMT Series can be configured to provide specific industrial output signals, according to 4-20 mA with HART digital communication. The LMT Series consists of two models (LMT100 & LMT200):

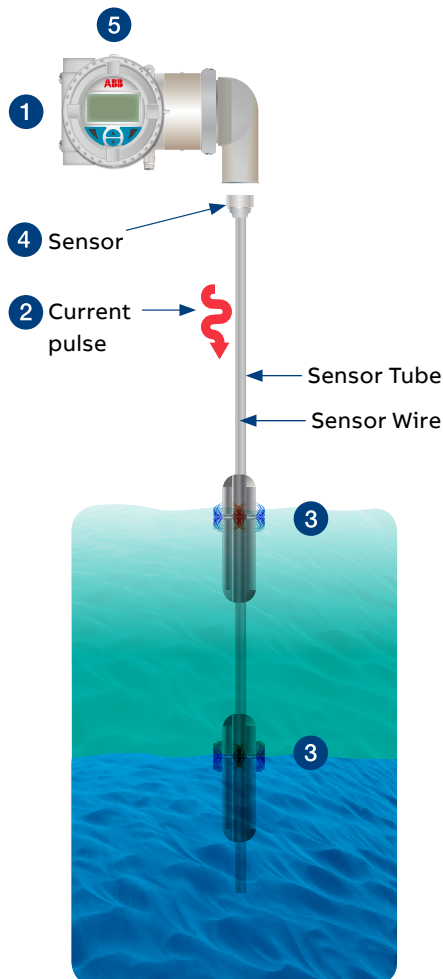

Figure 1 LMT100 (insertion-mounted)

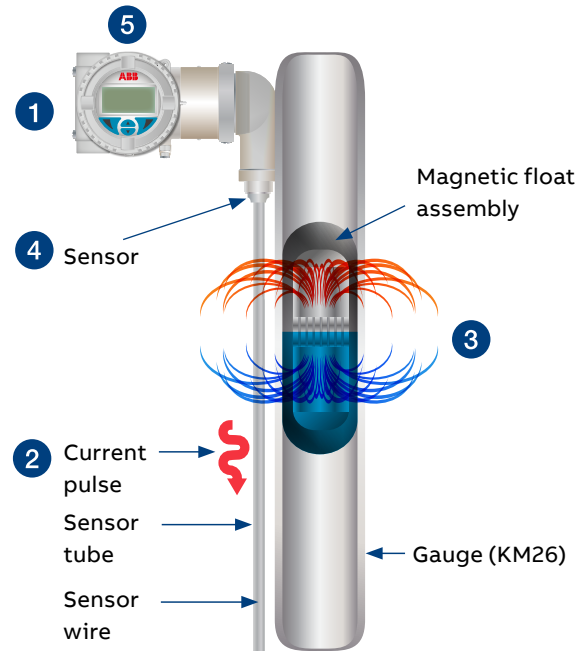

Figure 2 LMT200 mounted on gauge (KM26)

The LMT Series is based upon the magnetostrictive principle.

- 1 The device electronics generates a low energy current pulse at fixed intervals.
- 2 The electrical pulses create a magnetic field which travels down a specialized wire inside the sensor tube.
- 3 The interaction of the magnetic field around the wire and the magnetic float causes a torsional stress wave to be induced in the wire. This torsion propagates along the wire at a known velocity, from the position of the magnetic float and toward both ends of the wire.
- 4 A patented sensing element placed in the transmitter assembly converts the received mechanical torsion into an electrical return pulse.
- 5 The microprocessor-based electronics measures the elapsed time between the start and return pulses (Time of Flight) and converts it into a position measurement which is proportional to the level of the float.

2 Safety

General safety information

The following Safety section provides an overview of the safety aspects that must be observed for operation of the device. For the detailed safety guidelines, refer to the LMT Series Safety Manual (SM LMT100200-EN A).

The device is constructed in accordance with international and local regulations and is deemed to be operationally safe. Additionally, the device is tested and shipped from the factory in perfect working condition. The information contained within this manual, as well as all applicable documentation and certification, must be observed and adhered to in order to maintain the factory-deployed condition throughout the LMT Series period of operation.

Full compliance with the general safety requirements must be observed during operation of the device. In addition to providing general information, the individual sections within this manual contain descriptions, processes and / or procedural instructions with specific safety information for that corresponding action.

Only by observing all of the safety information can the user minimize the risk of hazards to personnel and / or the environment. The provided instructions are intended as an overview only and do not contain detailed information on all available models or every conceivable scenario that may arise during setup, operation and / or maintenance work.

For additional information, or in the event of specific issues not covered within these operating instructions, please contact the manufacturer. ABB declares the contents of this manual are not part of any prior or existing agreements, commitments or legal relationships and are not intended to amend those that are already in place.

CAUTION - Minor injuries.

Only qualified and authorized personnel are to be tasked with the installation, electrical connection, commissioning and maintenance of the transmitter. Qualified personnel are those individuals who have experience in the installation, electrical connection, commissioning and operation of the transmitter or similar devices and hold the necessary qualifications. These qualifications include but are not limited to:

- Training or instruction – authorization to operate and maintain devices or systems according to safety engineering standards for electrical circuits, high pressures and aggressive media
- Training or instruction in accordance with safety engineering standards regarding maintenance and use of adequate safety systems.

For reasons of safety, ABB recommends that only sufficiently insulated tools, conforming to IEC EN 60900, be used.

Since the transmitter may form a link within a safety chain, it is recommended that the device be replaced immediately if defects are detected. In the event of use in a hazardous area, only non-sparking tools are to be used.

In addition, the user must observe all relevant safety regulations regarding the installation and operation of electrical systems and the relevant standards, regulations and guidelines concerning explosion protection.

WARNING - Bodily injury.

The device can be operated at high levels of pressure and with aggressive media. As a result, serious injury or significant property damage may occur if this device is operated incorrectly.

Improper use

The LMT Series magnetostrictive transmitters are designed for reliable and accurate measurement of liquid levels in the industrial applications. Use the LMT for this purpose only. The manufacturer accepts no liability for any form of damage resulting from improper use!

It is prohibited to use the device for the following but not limited to these purposes:

- As a climbing aid (for example, for mounting purposes) port for pipes.
- Removing material (for example, by drilling the housing)

Technical limit values

The device is designed for use exclusively within the values stated on the identification plates (Refer to Section 4.1 Identification) and within the technical limit values specified on the data sheets.





The following technical limit values must be observed:

- The maximum working pressure must not be exceeded.
- The maximum ambient operating temperature must not be exceeded.
- The maximum process temperature must not be exceeded.
- The housing protection type must be observed.

Warranty provision

Using the device in a manner that falls outside the scope of its intended use, disregarding this manual, using underqualified personnel or making unauthorized alterations releases ABB from any liability for any resulting damage. This renders the manufacturer's warranty null and void.

Use of instruction

	DANGER - Serious damage to health / risk to life This symbol in conjunction with the signal word "DANGER" indicates an imminent electrical hazard. Failure to observe this safety information may result in death or severe injury.
	WARNING - Bodily injury This symbol in conjunction with the signal word "WARNING" indicates a potentially dangerous situation. Failure to observe this safety information may result in death or severe injury.
	CAUTION - Minor Injuries This symbol in conjunction with the signal word "CAUTION" indicates a potentially dangerous situation. Failure to observe this safety information may result in minor or moderate injury. This symbol may also be used for property damage warnings.
	NOTICE - Property Damage This symbol indicates a potentially damaging situation. Failure to observe this safety information may result in damage to or destruction of the product and / or other system components.
	IMPORTANT (NOTE) This symbol indicates operator tips, particularly useful information or important information about the product or its further uses. The signal word "IMPORTANT (NOTE)" does not indicate a dangerous or harmful situation.

Operator liability

In instances where corrosive and / or abrasive materials are being measured, the user must check the level of resistance of all parts that are coming into contact with these materials. ABB offers guidance in the selection of material but does not accept liability in performing this service. The user must strictly observe the applicable national regulations with regards to installing, functional testing, repairing and maintaining electrical devices.

Qualified personnel

Installing, commissioning and maintaining the device may be performed only by trained personnel who are authorized by the plant operator. These trained personnel must have read and understood this manual and must comply with its instructions.

Returning devices

For the purpose of returning the device for repair or recalibration, use the original packaging or other suitably secure shipping method. The sender should contact the factory for return authorization number and fill out return form (provided at the end of the manual) and include it with the device. According to C guidelines other local laws for hazardous materials, the owner of the corresponding hazardous waste is responsible for its disposal. The owner must observe the proper regulations for shipping purposes. All devices returned to ABB must be free of any hazardous materials (for example, acids, alkalis and solvents).

Disposal

ABB actively promotes environmental awareness and has an operational management system that meets the requirements of DIN EN ISO 9001:2000, EN ISO 14001:2004 and OHSAS 18001. ABB products are intended to have minimal impact on the environment and individuals during their manufacture, storage, transport, use and disposal.

This adherence to environmental standards includes the use of natural resources. In this endeavor, ABB maintains an open dialog with the public through its publications.

The product / solution is manufactured from materials that can be reused by specialized recycling companies.

Information on WEEE Directive 2002/96/EC (Waste Electrical and Electronic Equipment)



Note : Starting from August 15th 2018, electrical and electronic equipment marked with the crossed-out wheeled bin symbol may not be disposed as unsorted municipal waste. Waste of electrical and electronic equipment (WEEE) shall be treated separately using the national collection framework available to customers for the return, recycling and treatment of WEEE.

Bear the following points in mind when disposing of them:

- As of 8/15/2018, this product will be under the open scope of the WEEE Directive 2012/19/EU and relevant national laws (for example, ElektroG - Electrical Equipment Act - in Germany).
- The product must be supplied to a specialist recycling company. Do not use municipal waste collection points. These may be used for privately used products only in accordance with WEEE Directive 2012/19/EU.

Safety information for electrical installation

WARNING - Bodily injury.

Electrical connections may only be established by authorized personnel in accordance with the electrical circuit diagrams. The electrical connection information in the manual must be observed; otherwise, the application protection type may be affected. Ground the measurement system according to requirements.

Safety information for inspection and maintenance

Corrective maintenance work may be performed only by trained personnel.

- Before removing the device, depressurize the device and any adjacent lines or containers.
- Check whether hazardous materials have been used as measured materials before opening the device. Residual amounts of hazardous substances may still be present in the device and could escape when the device is open
- Within the scope of operator responsibility, check the following as part of a regular inspection:
 - Pressure-bearing walls / lining of the level device
 - Measurement-related function
 - Leak-tightness
 - Wear (corrosion)

WARNING - Bodily injury.

There is no EMC protection or protection against accidental contact when the housing cover is open. There are electric circuits within the housing which are dangerous if touched. Therefore, the auxiliary power must be switched off before opening the housing cover.

WARNING - Bodily injury.

The device can be operated at high pressure and with aggressive media. Any process media released may cause severe injuries. Depressurize the pipeline / tank before opening the transmitter connection.

Explosives atmospheres installation

For installation requirements in Explosives Atmospheres applications refer to IEC 60079-14 and any local Safety or Electric Code regulations mandatory in your area.

For specific conditions for safe use of the LMT100 and LMT200, refer to the LMT Series Safety Manual (SM LMT100200-EN A).

3 Transmitter Overview

Transmitter components overview

The following represents an exploded view of the components comprising the LMT Series level transmitter (see Figure 3).

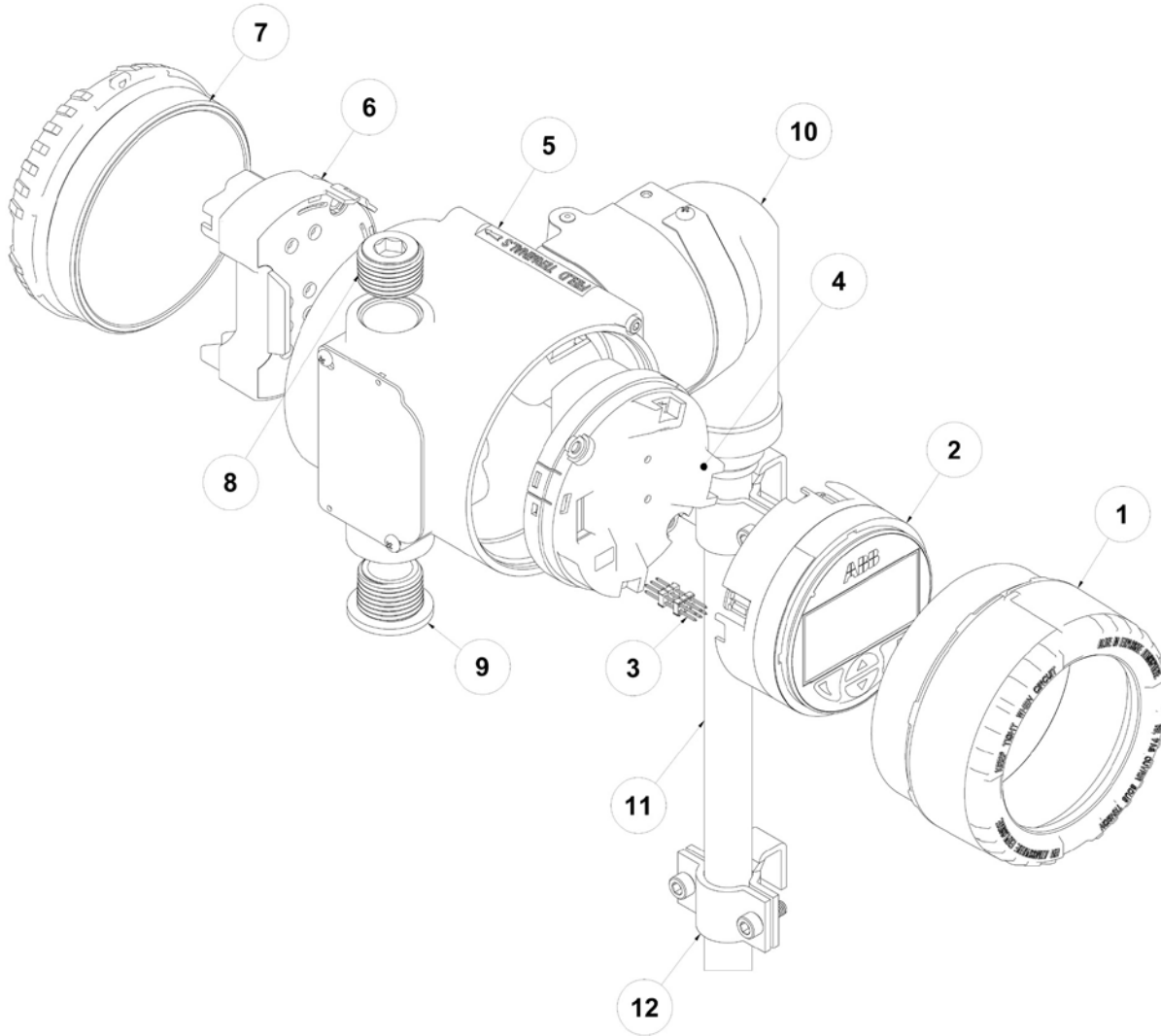

Figure 3 Exploded view of LMT Series transmitter

1	TopWorks Window Cover
2	HMI Display Assembly
3	HMI Connector
4	Communication Board
5	TopWorks Housing
6	Terminal Board
7	TopWorks Blind Cover
8	Agency Approved Plug
9	Plastic Plug
10	Sensor Elbow Housing
11	Sensor Tube
12	LMT200 Mounting Bracket

4 Unpacking

Identification

The transmitter is identified by the name plates. (A) The nameplate provides information (see figure 4) concerning the model number, probe length, sensor material, process connection type, process connection material, maximum pressure ratings, power supply, output signal, serial number, maximum processed temperature limits and Maximum ambient temperature limits. (B) The certification plate contains the certification-related parameters for use in a hazardous area.

Please refer to the serial number when speaking to ABB service department personnel.

IMPORTANT (NOTE)

The name plates shown here are only examples. The name plates attached to the device may be different to what you see below.

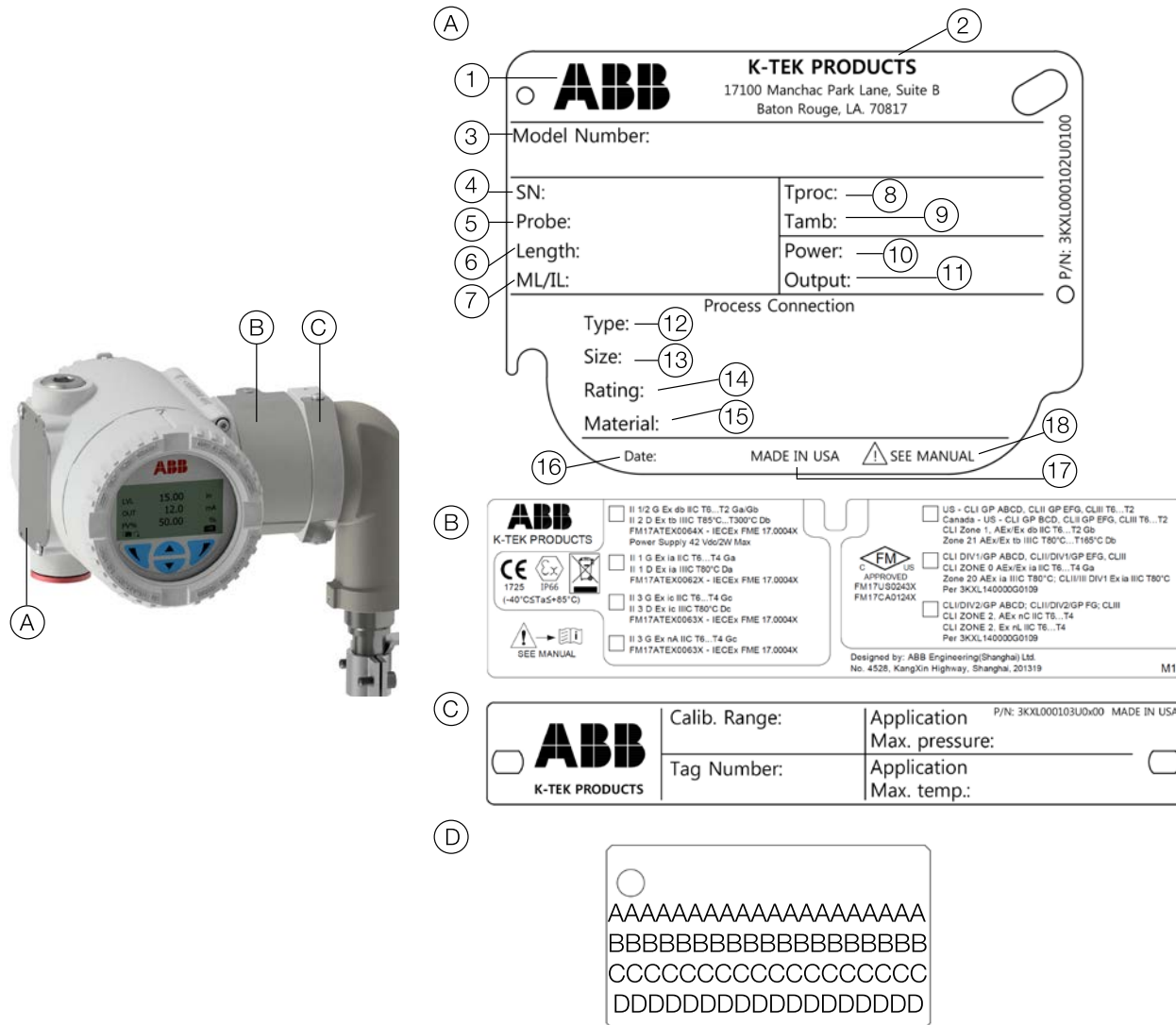

Figure 4 Identification Plates

- (A) Name plate - 1. Manufacturing Logo 2. Manufacturing Address 3. Model Number 4. Serial Number 5. Probe Material 6. Probe Length 7. ML = Measurement length (LMT200) / IL = Insertion Length (LMT100) 8. Limits of Measuring Process Temperature 9. Ambient Temperature Range 10. Power Supply 11. Current Output 12. Process Connection Type 13. Process Connection Size 14. Pressure Rating or maximum allowable pressure 15. Process Connection Material 16. Date of Production in yyyy/mm format 17. Country of Manufacture 18. Symbol: Read Instructions Before Use

- (C) Tag plate
- (D) Tag plate with customer specific data

IMPORTANT (NOTE)

All documentation, declarations of conformity, and certificates are available in ABB's download area. www.abb.com/level

- (B) Specific data plate with Ex marking

Optional wired on SST plate

The LMT Series of transmitters can be supplied with an optional wired-on, stainless-steel plate (Figure 4, D). The plate is laserprinted with custom text, as specified by the user. The available space consists of 4 lines with 32 characters per line. The plate will be connected to the transmitter with a Stainless Steel wire.

Unpacking and Handling

- Remove the transmitter and all included hardware from the shipping carton.
- Do not discard the packaging material until the installation is complete.
- Normal good practice should be observed during handling especially those with sensor tubes that exceed 8 feet should be handled with care and assistance.

Transport and storage

- After unpacking the level transmitter, inspect it for damage.
- Check the packaging for accessories.
- During intermediate storage or transport, only store the level transmitter in the original packaging.
- If required, storage prior to installation should be indoors at ambient temperatures, not to exceed the following:
 - Temperature range: -40°C to 85°C (-40°F to 185°F)
 - Humidity: 0 to 95% R.H., non-condensing

For information on permissible ambient conditions for storage and transport, refer to the specification section of the datasheet. Although there is no limit on the duration of storage, the warranty conditions stipulated on the supplier's order of acknowledgement still apply.

WARNING

Transmitter probes with a W3 or W7 option have a flexible sensor tube. When removing the sensor from the sensor well, do not expose the sensor to moisture. Additionally, it is important to prevent water from entering the sensor well.

5 Mounting

General

Read the following installation instructions carefully before proceeding. Failure to observe the warnings and instructions may cause a malfunction or personal hazard. Before installing the transmitter, ensure the device design meets the requirements of the measurement point from both a measure technology and safety point of view.

This applies in respect to:

- Explosion-protection certification
- Measuring range
- Pressure
- Temperature
- Operating voltage

Check the suitability of the materials in regards to their resistance to the media. This applies to the:

- Gasket
- Process connection and seals
- Float
- Probe
- End connection

In addition, the relevant directives, regulations, standards and accident prevention regulations must be observed. Measurement accuracy is largely dependent on the correct installation of the level transmitter and, if applicable, mounting arrangement. In instances where it is possible, the measuring setup should be free from critical ambient conditions such as large variations in temperature, vibrations or shocks.

NOTICE – Property damage.

If unfavorable ambient conditions cannot be avoided for reasons relating to building structure, measurement technology and / or other issues, the measurement quality may be affected.

All installations

- Prior to installation, verify the model of the transmitter is suitable for the intended application. Information regarding the model specifications may be found on the corresponding LMT Series datasheets.
- The electronics housing should be maintained in the following ambient conditions:
 - Temperature range: –40°C to 85°C (–40°F to 185°F)
 - Humidity: 0 to 95% R.H. non-condensing
- Do not use device as a support when mounting

Hazardous area considerations

Only if the certification plate is permanently fixed on the neck of the transmitter top housing. For specific conditions for safe use of the LMT100 and LMT200, refer to the LMT Series Safety Manual (SM LMT100200-EN A).

CAUTION

When the certification plate label is not identified the type of protection, the user shall, on installation, mark the label with the type of protection. The certification will be void if there are more than one type of protection marked on the label.

IP Protection and Designation

The housing for the LMT Series transmitters is certified as conforming to protection type IP66 (according to IEC 60529) or NEMA 4X (according to NEMA 250).

The first number indicates the type of protection the integrated electronics have against the entry of foreign bodies, including dust. “6” means that the housing is dust-proof (i.e., no ingress of dust). The second number indicates the type of protection the housing has against the entry of water. “6” means that the housing is protected against water; specifically, powerful jets of water under standardized conditions.

Mounting the transmitters

Mounting an LMT100

When mounting the LMT100 level transmitters, the following rules need to be applied to ensure proper installation:

- Over-tightening the compression tube fitting can cause the tubing to kink or flare and cause the inside wire to dampen the return signal.
- When inserting the LMT100, depending on the height, the user needs to ensure that the float does not drop down on the float stop or probe end connection. This can cause the end connection (c-clip) to come off and the float to be lost in the tank.
- After installing the LMT100, before tightening the compression fitting, bring the unit up at least 2 inches from the neck of the housing to the top of the connection.
- When installing the LMT100, be careful to not bend the probe. This can cause the float to hang-up. For specific conditions for safe use of the LMT100 and LMT200, refer to the LMT Series Safety Manual (SM LMT100200-EN A).
- Proceed with the electrical installation (refer to Section 6 “Transmitter Wiring”).

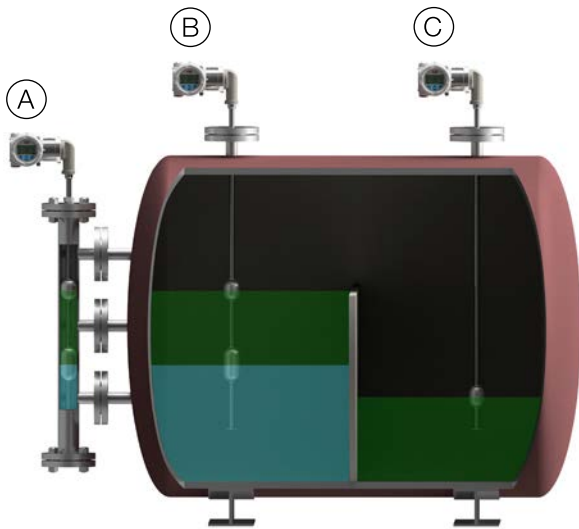

Figure 5 LMT100 Mounting

LMT100 Transmitters installations:

- (A) Installed in external chambers in a level and interface measurement application
- (B) Installed directly into vessel, measuring level and interface level
- (C) Installed directly into vessel measuring level only

⚠ CAUTION

Do not run an external magnet on the outside of the sensor and then take the magnet off. This leaves residual magnetic properties on the wire, causing a false echo. If a magnet is used, be sure to run the magnet from the sensor elbow to the probe tip to ensure no residual magnetic field is present.

Compression fittings

When fitted with a compression fitting as the process connection, the sensor tube is shipped with a set of TEFLON® ferrules and a set of metal ferrules in a separate bag. The TEFLON® ferrules are only intended for use in applications with operating pressures at or below 3.4 bar (50 psig) and process temperatures at or below 204°C (400°F). For higher operating pressures or temperatures or for permanent installation, replace the TEFLON® ferrules with metal ferrules.

Floats

The float is a key component of the LMT Series transmitter that must be matched to the medium in respect of density, pressure resistance and material durability. Every LMT float is precisely engineered to customer application, ensuring optimal accuracy and performance. Precisely spaced magnets create a 360° magnetic field coverage, safeguarding level transmitter and gauge performance, even the most challenging applications. Several materials of construction available including Titanium, Monel®, Hastelloy® C, Stainless Steel, and Plastics. Tefzel®, Halar®, TEFLON® S protective coatings are also available.

During installation, it may be necessary to remove the float and spacer (if included) from the sensor tube. For proper operation, the float must be reinstalled using the proper orientation. Floats may be marked with “Top for SPM” or “Top for LMT”. These ends of the float must face the transmitter head. Other floats may be marked with an arrow indicating the proper orientation. If a float is etched with information but does not indicate a proper orientation, it will be bidirectional and can be installed in either direction.



Figure 6 Floats

IMPORTANT NOTE

During installation, take care not to bend the probe tube, and protect the float from shock and impact loads. If the float is removed during installation, it must be slid back onto the probe tube afterwards for LMT100 with the “TOP” marking oriented towards the sensor head end, to enable correct measurements to be made. For LMT200, the float must be installed in the chamber in proper orientation.

Sensor wells

Certain transmitter options have the sensor tube inserted into a sensor well. These options allow the sensor tube and housing to be removed for service without breaking the seal on the vessel. These options include (consult model number) W1, W2, W3, W4, W5, W6, C3, C4, W7, J4 and J5.

Sensor Wells		
Model	Sensor Type	Sensor Well
W1, W2,	½ in. rigid	⅝ in. tube
W4, W5, W6, C3, C4	⅝ in. rigid	¾ in. pipe (typical)
W3,	½ in. flexible stainless	⅝ in. tube
W7	⅝ in. flexible plastic	1 in. sectioned tube
J4, J5	½ in. rigid	⅝ in. tube with TEFLON® jacket

The compression fittings that hold the sensor inside the sensor well contain TEFLON® ferrules. It is not necessary to change the TEFLON® ferrules to metal. This connection will not be required to retain process pressure.

IMPORTANT NOTE

When installing/removing a sensor into/from a sensor well, a wrench shall be used on both the sensor, and the sensor well. The sensor installation torque shall not be transferred to the sensor well.



Figure 7 Sensor well installation

Assembly instructions for W7 flexible probes

- 1 Prepare section joints by lubricating the O-ring and mating surface of male threaded portion (Figure 8). For detail refer to LMT100 Probe Type W7 in section 12 Dimensional Drawing

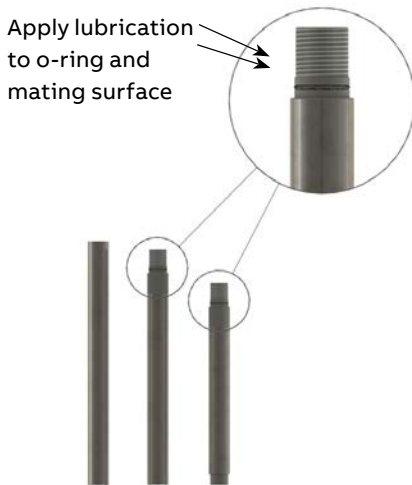

Figure 8 W7 Well Threaded Connection

- 2 Lower the bottom tube section with the float stop and float into tank.
- 3 Insert the top of the tube assembly through the mounting flange.
- 4 Add the next section of tube and thread together using thread locking fluid (Loctite® 242®) to secure joints.
- 5 Repeat step 4 for each middle tube section.

- 6 Add the last section (TOP) of the tube with 1 in. compression fitting, and thread into the assembly using thread locking fluid (Loctite® 242®) to secure the joint.
- 7 Thread the tube compression fitting into the mounting flange using thread sealant.
- 8 Lower the tube assembly until it hits the bottom of the tank. Raise the sensor well back up 12 mm (½ in) and secure the assembly in place by tightening the tube compression fitting.

⚠ WARNING

When handling flexible tubing, do not bend any section of the tube into a diameter of less than 4 feet. This could permanently damage the internal assembly and prevent proper operation.

- 9 Insert the flexible probe into the tube assembly. Secure flexible probe assembly to stainless-steel tube using 1in tube to 1in tube compression fitting.

⚠ WARNING

Ensure that the assembly is tight and properly sealed to prevent moisture entry.

Mounting the LMT200

When mounting the LMT200 level transmitter, the following rules need to be applied to ensure proper installation:

- If the LMT Series device was purchased with the KM26 magnetic level gauge (MLG), it will have been shipped mounted and positioned and will not typically require any further mechanical adjustment.
- The sensor tube is labeled with a factory zero mark. The line on this tag should be aligned with the zero on the scale of the level gauge.

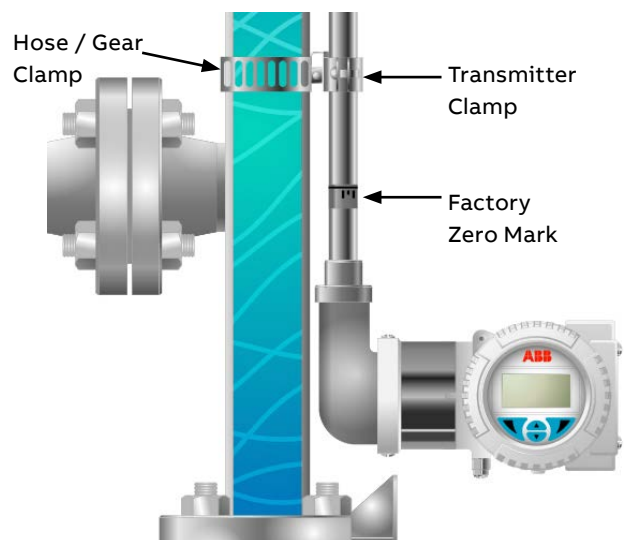

Figure 9 LMT200 Mounting

- The electronic housing, in reference to the sensor tube, is indicated by the model number:
 - B1 or B2 – the housing is at the bottom of the sensor tube
 - T1 or T2 – the housing is at the top of the sensor tube
- LMT Series transmitters are factory-calibrated to the measuring length indicated by the ML on the device tag, unless otherwise specified upon ordering.
- Attach the LMT Series device to the side of the magnetic level gauge (MLG) using the included worm gear clamps.
- The gear clamps should slide between the scale and the level gauge chamber. It may be necessary to loosen the gear clamps holding the scale to the MLG to install the transmitter clamps. Do not loosen all of the gear clamps all at once.
- Align the factory zero mark with the “0” measurement mark on the scale of the center of the bottom process connection and tighten all gear clamps.

⚠ CAUTION

Do not mount the LMT200 directly next to or touching the steam tracing, if installed on chamber. It is not recommended to mount the LMT200 under an insulation blanket. If this is done, verify the sensor design can withstand the full process temperature, and do not insulate any closer than 6” from the sensor elbow connection.

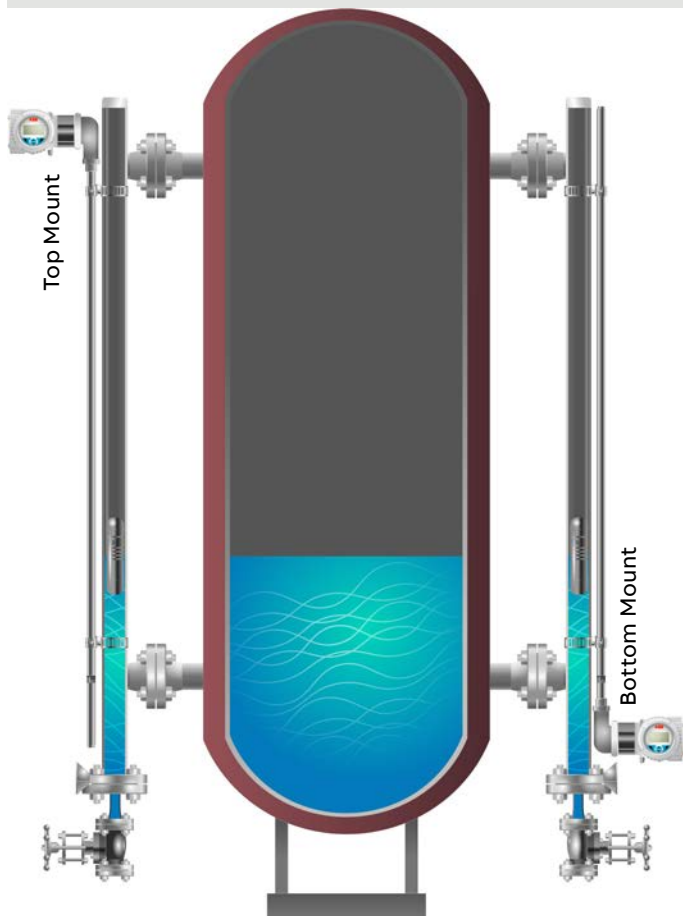

Figure 10 LMT200 Single Level Top / Bottom Mount

- Prior to installation, verify the model of the transmitter is suitable for the intended application. Information regarding the model specifications may be found on the corresponding LMT Series datasheets.
- LMT Series transmitters mounted in high vibration areas (such as near a compressor) should be mounted using vibration isolators. Vibration isolators take the place of the standard mounting clamps.
- The electronics housing should be maintained in the following ambient conditions:
 - Temperature range: -40°C to 85°C (-40°F to 185°F)
 - Humidity: 0 to 95% R.H. non-condensing
- Proceed with the electrical installation (Refer to Section 6 “Transmitter Wiring”).

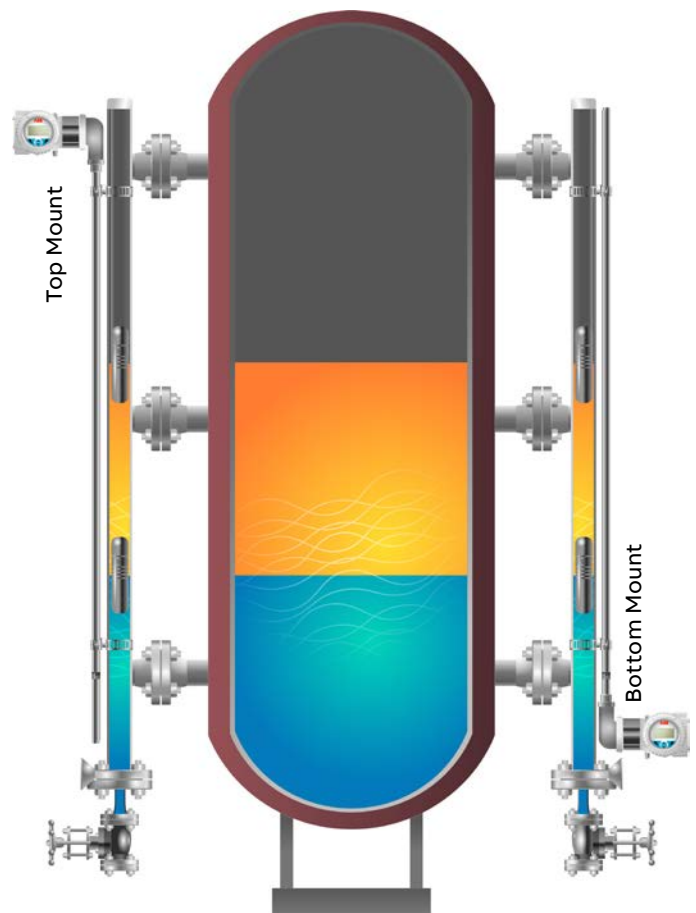

Figure 11 LMT200 Dual Level Top / Bottom Mount

Insulation blankets or pads

- When an LMT Series transmitter is mounted on a level gauge with an insulation pad or blanket, the insulation must pass between the sensor tube and the body of the level gauge. Wrapping insulation around the sensor may cause damage to its internal components.
- A thick insulation blanket may require flattening to allow the installation of the LMT Series transmitter.
- Using the zero factory mark as a reference, mark and cut 19 mm x 19 mm ($\frac{3}{4}$ inch x $\frac{3}{4}$ inch) holes in the insulation pad or blanket that correspond to each mounting clip of the LMT Series transmitter.

- Remove the insulation blanket from the MLG just enough to slide the gear clamps between the scale assembly and the level gauge chamber. It may be necessary to loosen the gear clamps holding the scale to the MLG to install the transmitter clamps.
- Mount the LMT Series transmitter to the MLG using the gear clamps by allowing the LMT Series transmitter mounting clamps to pierce the holes in the insulation blanket.
- Align the factory zero mark with a “0” measurement mark on the scale or the center of the bottom process connection and tighten all gear clamps.
- Re-attach the insulation blanket.
- Proceed with electrical installation (Refer to Section 6 “Transmitter Wiring”).

Cryogenic (low temperature) applications

- As an option, some cryogenic transmitters are mounted in insulation wells attached to the level gauge. This allows the removal of the transmitter from service without removing the insulation.
- Insulation wells mount to the MLG using the included gear clamps and following the steps in the mounting of standard units.
- Insulate the MLG and insulation well, per end user specifications.

90° Probes

Select LMT Series of transmitters are manufactured with a 90° bend near the housing to distance the electronics housing from the temperature of the process, to remote the sensor from the chamber or to allow access to the electronics when the sensor mounted under cryogenic insulation. These are identified by the model number as XXX-SEH. These select transmitters are equipped with a mounting bracket that must be attached to the body of the level gauge with a transmitter clamp.

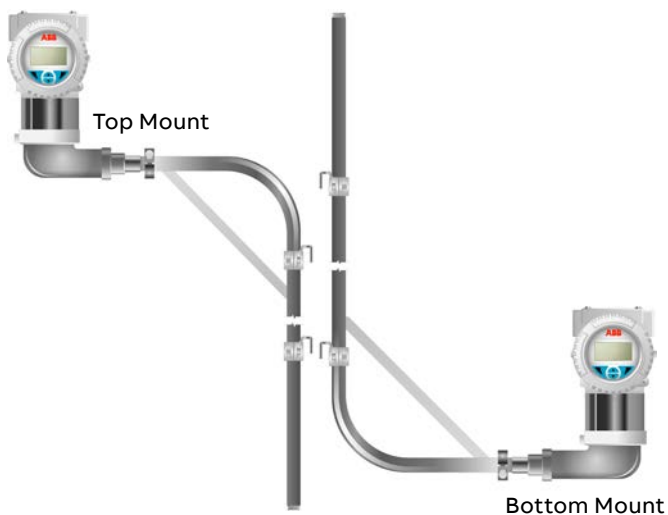

Figure 12 90° Top / Bottom Mount

Transmitter removal

- Remove electrical power from the transmitter.
- Disconnect the transmitter field wiring and electrical connection.

- Loosen the gear clamps and remove the transmitter from the MLG.
- Be careful not to bend the sensor tube. Transmitters over 8-feet in length should be handled with care and assistance.
- The LMT Series transmitter installed in an insulation well may be removed by loosening the compression fitting and sliding the sensor out of the tube.

IMPORTANT NOTE

When installing/removing a sensor into/from a sensor well, a wrench shall be used on both the sensor, and the sensor well. The sensor installation torque shall not be transferred to the sensor well. Refer to Figure 7

LMT200 valve positioner

In the valve positioning application, the transmitter is bolted to the yoke of the actuator with two mounting brackets that are supplied with the transmitter. A third bracket is secured to the stem connector. This bracket holds the magnet that provides the signal to the transmitter. The clearance between the magnet and the sensing tube of the LMT200 is approximately 6.35 mm (¼ in). This dimension is not critical and can vary slightly along the length of the transmitter. The magnet should not contact the sensing tube at any point in its travel. The brackets supplied with the transmitter do not include mounting holes. These will be drilled in the field to accommodate the various sizes of actuators that will be encountered. The transmitter is calibrated in place by using either the integral HMI display or handheld devices. The vertical alignment of the transmitter is not critical and the zero and span can be set anywhere along the active portion of the transmitter.

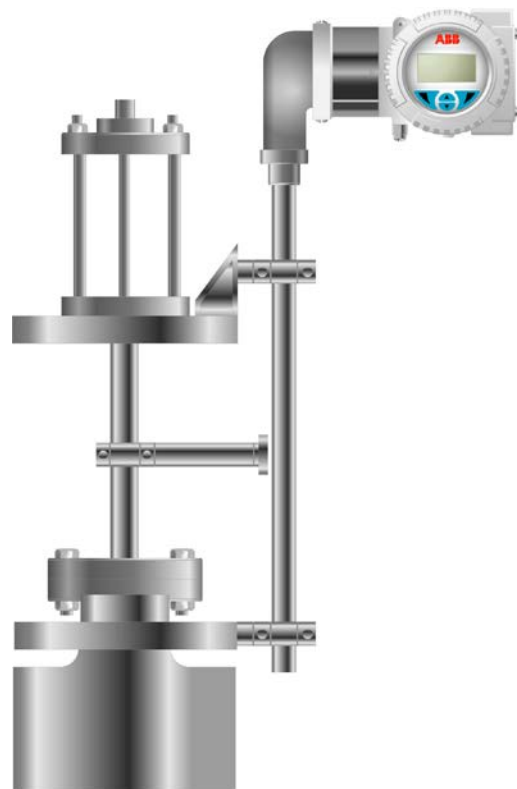

Figure 13 LMT200 Valve Positioner

Pressure Equipment Directive (PED) (97/23/CE)

This product conforms to the EC directives listed in the device-specific EC declaration of conformity. It is designed in accordance with safe engineering practices to meet state of the art safety requirements, has been tested and left the factory in a condition in which they are safe to operate.

Transmitter housing rotation

To improve field access to the wiring or visibility to the optional HMI display, the transmitter housing can be rotated up to 360° and fixed in any position. A stop prevents the housing from being rotated too far. To rotate the housing, loosen the housing stop retaining-screw by approximately 1 rotation (do not pull out), rotate the housing to the required position and secure by re-tightening the retaining-screw (see Figure 14).

NOTICE – Property damage.

Do not attempt to rotate the elbow to sensor tube connection. Rotation can cause damage to the sensor. If rotation is required on the LMT100, loosen the compression fitting or rotate the process connection. If rotation is required for the LMT200, loosen the mounting clamps.



Figure 14 Transmitter Housing Rotation

Installing / removing the external push buttons

- Loosen the screws that hold the nameplate in place, and slide the plate to gain access to the local adjustments.
- Loosen the push button assembly screws (1) that secure the plastic element. The element is spring-loaded.
- Remove the gaskets (3) that are positioned below the push-button plastic cover (2).

The three push buttons (4) and the relevant springs (5) can now be removed from their seat (see Figure 15).



Figure 15 External push button assembly components

Installing / removing the HMI display

- Unscrew the housing cover of the communication board / HMI side.

IMPORTANT NOTE

With an Ex d / flame-proof design, please refer to the securing the housing cover in flame-proof areas section.

- Attach the HMI display. Depending on the mounting position of the level transmitter, the HMI display may be attached in four different positions.
- This enables + 90° or + 180° rotations (see Figure 16).

IMPORTANT NOTE

Retighten the housing cover until it is hand-tight.

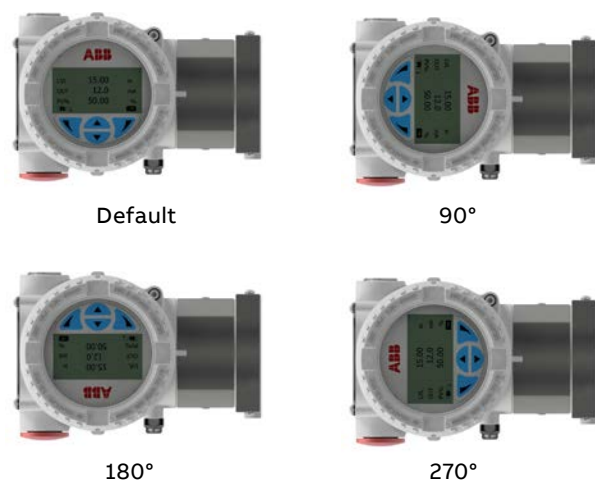

Figure 16 Windowed front cover and HMI display

Integral display rotation

When the optional integral display meter is installed, it is possible to mount the display in 4 different positions, rotated clockwise or counterclockwise with 90° steps. To rotate the display, open the windowed cover (hazardous area precautions

must be respected) and pull the display housing from the communication board. Reposition the display connector according to the preferred position. Push the display module back onto the communication board. Ensure the plastic fixing locks are in place.

Securing the housing in flame-proof areas

Each of the front faces of the electronics housing features a locking screw (hex-head socket screw) on the bottom side.

- Install the housing cover to the housing by hand-tightening it.
- Turn the locking screw counterclockwise to secure the housing cover. This involves unscrewing the screw until the screw head stops at the housing cover.

6 Transmitter wiring

⚠ DANGER - Serious damage to health / risk to life

Observe all applicable regulations governing electrical installation. Connections must be established only in a zero-voltage state. Since the transmitter does not switch-off elements, overvoltage protection devices, lightning protection and / or voltage separation capacity must be provided at the plant. (overvoltage / lightning protection is optional). Check that the existing operating voltage corresponds to the voltage indicated on the name plate. The same wires are used for both the power supply and output signal. In case the surge protection option is present and the transmitter is installed in a hazardous area, the transmitter has to be supplied power from a voltage source isolated from mains (galvanic separation). Furthermore, the potential equalization for the entire powering cable must be guaranteed since the intrinsic safety circuit of the transmitter is grounded.

Electrical shock can result in death or serious injury. Avoid contact with the leads and terminals. High voltage can be present on leads and cause electrical shock.

Do NOT make electrical connections unless the electrical code designation stamped on the transmitter data plate agrees with the area classification in which the transmitter is to be installed. Failure to comply with this warning can result in fire or explosion.

Cable connection

Depending on the design supplied, the electrical connection is established via a cable entry, M20 x 1.5 or ½" NPT thread. The screw terminals are suitable for wire cross sections up to 2.5 mm² (AWG 14).

IMPORTANT NOTE

With transmitters for use in "Zone 2", a qualified cable gland for this type of protection must be installed by the customer (refer the LMT Series Safety Manual (SM LMT100200-EN A). M20 x 1.5 threads are located in the electronics housing for this purpose. For transmitters with a flame-proof enclosure (Ex d) type of protection, the housing cover must be secured using the locking screw. The screw plug that may have been supplied with the transmitter must be sealed at the plant using Molykote DX. The installer assumes responsibility for any other type of sealing medium used. Increased force is required to unscrew the housing cover after an interval of several weeks. This is not caused by the threads but is due to the type of gasket.

⚠ CAUTION

- The cable entry device shall comply with the requirements of EN 60079-0 and maintain IP 54 or better as required by the installation conditions.
- Field wiring should be rated at least 10°C above the device maximum ambient temperature

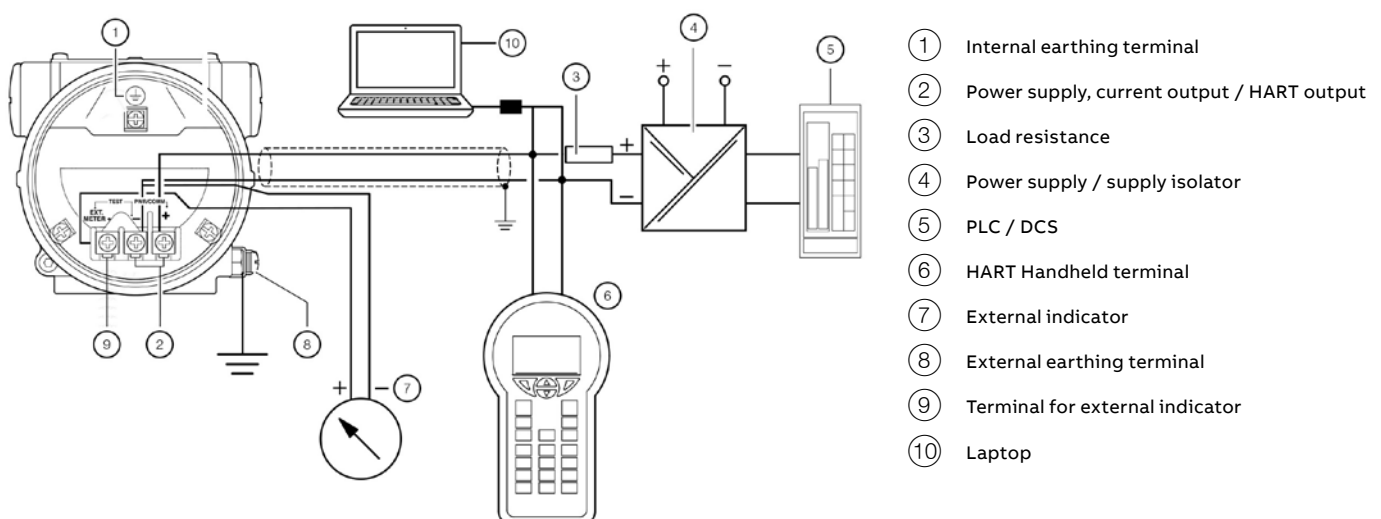

Figure 17 LMT HART wiring scheme

Supply requirement

For signal / power connections, use twisted, stranded pairs of wiring, 18 to 22 AWG / 0.8 to 0.35 mm² Ø up to 1500 m (5,000ft). Longer loops require lower gauge wire. If a shielded wire is used, the shield should be grounded only at one end, not both ends. In case of wiring at the transmitter end, use the terminal located inside the housing marked with the appropriate symbol.

The 4-20 mA output signal and the dc power supply to the transmitter are carried from the same pair of wires. The supply voltage at the transmitter terminals must be between the limits of 12 Vdc and 42 Vdc.

For Ex ia and intrinsically safe (FM and Canadian) approval power supply must not exceed 30 Vdc. In some countries, the maximum power supply voltage is limited to a lower value. For maximum power supply voltage, refer to the appropriate local approval designation for the area.

The actual possible line length of the electrical circuit depends on the resistance and can be estimated using the following formula:

$$R = 46 \times V_{cc} - 552$$

$$L = (23 \times V_{cc} - 276 - 0.5 \times R_s) / \rho$$

Where:

L = Line length in meters

R = Total resistance in Ω (ohms)

V_{cc} = Power supply voltage

R_s = Any additional series resistance in Ω (ohms)

ρ = Cable resistance per unit of length

Avoid routing cables with other electrical cables (with inductive load) or near large electrical equipment.

Wiring procedure

Follow these steps to wire transmitter:

- Remove the terminal cap from one of the two electrical connection ports located at both sides of the transmitter housing.
- The connection ports may have a ½-inch internal NPT or M20 threads. Various adapters and bushings can be fitted to these threads to comply with plant wiring (conduit) standards.

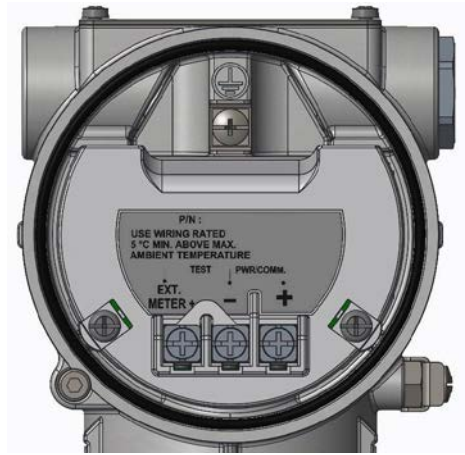

Figure 18 Terminal board without surge option

Terminal	Function / Comment
PWR/COMM +	Power supply, current output / HART® output
PWR/COMM -	HART® output
EXT. METER	Not assigned

- Remove the housing cover on the field terminals side. The user needs to then view the indication on the label at the neck of the housing.

⚠ WARNING

In an explosion-proof / flame-proof installation, do not remove the transmitter covers when power is supplied to the unit.

- Run the cable through cable gland and the open port.
- Connect the positive lead to the + terminal and the negative lead to the – terminal.
- Plug and seal the electrical ports. Ensure that upon completion of the installation, the electrical ports are properly sealed against entry from rain and / or corrosive vapors and gases.

⚠ WARNING

General risks. Cable, cable gland and unused port plug must be in accordance with the intended type of protection (for example, intrinsically safe and explosion-proof) and the degree of protection (for example, IP6x according to IEC EN 60529 or NEMA 4x). See also the addendum for Ex Safety Aspects and IP Protection. In particular, for explosion-proof installation, remove the red, temporary plastic cap and plug the unused opening with a plug certified for explosion containment.

- If applicable, install the wiring with a drip loop. Arrange the drip loop so the bottom is lower than the conduit connections and the transmitter housing.
- Place the housing cover back, turn it to seat the O-ring into the housing and then continue to hand-tighten until the cover contacts the housing, metal-to-metal. In Ex-d (explosion-proof) installation, lock the cover rotation by turning the set nut.

Grounding

A terminal is available on both the outside of the housing and in the plug for grounding (PE) the transmitter. Both terminals are electrically connected to one another (see Figure 19).



Figure 19 Ground connection on transmitter housing

All transmitters are supplied with an external ground connection for protective grounding. Wire this ground connection to a suitable earth ground. For a transmitter measuring loop, an earth ground should maintain a resistance of 5 ohms or less. Use a heavy-duty conductor, at least 15 AWG / 1.6 mm² Ø.

⚠ WARNING - General risks.

A protective grounding connection is absolutely necessary to ensure personnel protection, to protect against surge (in case of installation of this option) and to prevent explosions in potentially explosive environments.

Integrated lightning protection

The transmitter housing must be connected using the grounding terminal (PE) by means of a short connection with the equipotential bonding. Equipotential bonding minimum diameter of 4 mm (AWG 12) is required throughout the cable routing area.

In case of transmitters with integrated lightning protection (optional), the intrinsically safe circuit is connected to the equipotential bonding for safety reasons.

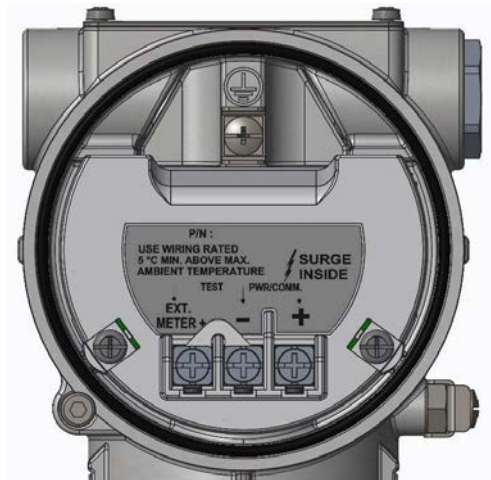

Figure 20 Terminal board with surge option

IMPORTANT NOTE

Test voltage withstand capability can no longer be ensured when this protective circuit is used.

7 Commissioning

Transmitter factory configuration consideration

The LMT Series level transmitters have been factory-calibrated to reflect the published performance specification; no further calibration is required under normal conditions. ABB typically configures the LMT Series level transmitters according to user requirements. A typical configuration includes:

- Tag number
- Calibrated span
- Display configuration

Preliminary checks prior to start-up

- Before beginning the commissioning procedure, ensure: The power supply is OFF
- The power supply is within the specified range (12 to 42 V DC)
- The pin assignment matches the connection diagram
- The transmitter is correctly grounded
- The transmitter is within temperature limits
- The transmitter is installed in a location free of excessive vibration
- The terminal cover is sealed

Local push buttons functionality

The LMT Series allows local adjustments via the on-board non-intrusive push buttons, when selected. The push buttons are located under the identification nameplate. To gain access to the local adjustments release the fixing screws of the nameplate and rotate clockwise the identification plate.

NOTICE

Operating the control buttons with a magnetic screwdriver is not permitted.

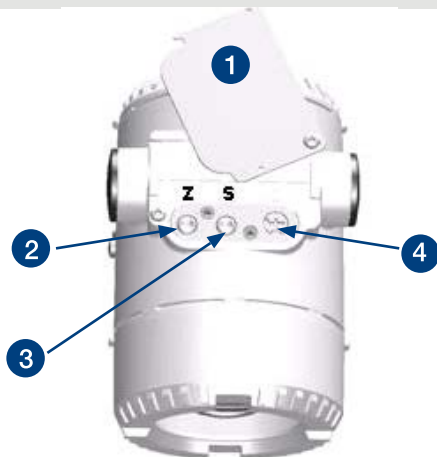

- ① Identification nameplate
- ② "Z" Zero push button
- ③ "S" Span push button
- ④ Write-protection button

Figure 21 Push Button Functionalities

Write protection

Write protection prevents the configuration data from being overwritten by unauthorized users.

If write protection is enabled, the "Z" and "S" buttons (either internal or external) are disabled. However, it is possible to read out the configuration data using the graphical user interface (DTM) or another, similar communication tool.

Write protection activation via external push button

The instrument features the external, non-intrusive push buttons, the write protection function can be performed as follows:

- Remove the identification plate (see Figure 22) by loosening the retaining screw that is situated on the bottom left corner.
- Use a suitable screwdriver to fully press the switch down.
- Turn the switch clockwise by 90°.

IMPORTANT NOTE

To deactivate the switch, slightly push it down and turn counterclockwise by 90°.

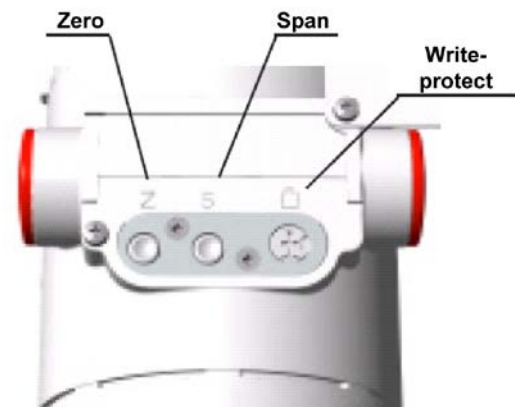

Deactivated protection

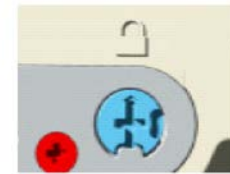

Activated protection

Figure 22 Write Protection Push Button

Write-protection via device software

Write-protection via device software is possible. Please refer to Section 8 "Operation" of this manual, under "Menu: Device Setup".

Failure Mode

Activation via hardware switch

To activate this function, it is necessary to proceed as detailed below:

- Remove instrument cover and standard HMI display (if installed)
- On the communication board, place dip switch 4 in the “up” position.
- On the communication board, place the dip switch #5 in the up position for fail low or down position for fail high.



Figure 23 Communication board

Failure mode via device software

Failure mode via device software is possible. Please refer to the Section 8 “Operation” of this manual under “Menu: Process Alarm”.

Analog and HART communication models

If the level applied falls within the values indicated on the name plate, the output current will be between 4 and 20 mA. If the level applied falls outside the set range, the output current will be between 3.5 mA and 4 mA. If the level applied exceeds the set limit, the output current will be between 20 mA and 22.5 mA (depending on the respective configuration).

Standard setting for error detection (alarm) 3.6 mA / 21 mA

The graphical user interface (DTM) or the HMI integral display (if installed) can be used to diagnose the error.

IMPORTANT NOTE

A brief interruption in the power supply results in initialization of the electronics (program restarts).

Verify proper power-up of the transmitter

Use a mA meter to measure the output current. When power is applied, the output should go to 4.00 mA for at least one (1)

second and then to either the measured level or an alarm condition output. If this does not occur, the transmitter may not be receiving enough power or the main electronic is defective. Excessive current of about 21 mA is also an indication of improper powerup or defective electronics (see Figure 24).

Valid current loop outputs

- **21 mA** – High alarm (the HMI display indicates level as ----) If the communication board switch #5 is set to fail high, a loss of signal or a problem with the configuration or a malfunction will cause the output to be set to the alarm condition of 20.99 mA.
- **20.5 mA** – Saturated high
When the level increases above the 20 mA point, the output will continue up to 20.5 mA and then saturates at this value until the level moves back down again.
- **4.00-20.00 mA** – Normal output range
- **3.8 mA** – Saturated low
When the level decreases below the 4 mA point, the output continues down to 3.8 mA and then saturates at this value until the level moves back up again.
- **3.6 mA** – Low alarm (the HMI display indicates level as ----) If the electronics board, switch 5 is set to FAIL LOW, a loss of signal or a problem with the configuration or a malfunction causes the output to be set to the alarm condition or 3.6 mA.

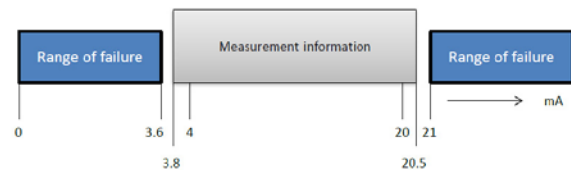

Figure 24 NAMUR NE-43 Diagnostic Fault Range

Range and span consideration

The LMT Series data sheets provide all the information concerning the range and span limits in relation to the model and sensor codes.

- URL Upper Range Limit of a specific sensor. This represents the measured value's highest set point that the transmitter can be adjusted to.
- LRL Lower Range Limit of a specific sensor. This represents the lowest value of the measured value that the transmitter can be adjusted to measure.
- URV Upper Range Value. The measured value's highest value by which the transmitter is calibrated.
- LRV Lower Range Value. The lowest value of the measured value to which the transmitter is calibrated.
- SPAN The algebraic difference between the Upper and Lower Range Values. The minimum span is the minimum value that can be used without degradation of the specified performance.

The transmitter can be calibrated with any range between the LRL and the URL with the following limitations:

$$\begin{aligned} \text{LRL} &\leq \text{LRV} \leq (\text{URL} - \text{CAL SPAN}) \\ \text{CAL SPAN} &\geq \text{MIN SPAN} \\ \text{URV} &\leq \text{URL} \end{aligned}$$

Factory settings

Transmitters are calibrated at the factory to the customer's specified measuring range. The calibrated range and tag number are provided on the tag plate. If this data has not been specified, the transmitter is delivered with the following configuration:

Parameter	Factory setting
Lower range value (LRV) 4 mA	4 mA
Upper range value (URV) 20 mA	20 mA
Damping	2 seconds
Transmitter failure (alarm)	Lowscale (3.6 mA)
HMI Default Operator Page (Optional)	1 line PV and output signal bar graph (1x6 + graph)

IMPORTANT NOTE

All of the configurable parameters on the left can be easily modified either through the optional HMI (with a HART handheld terminal) or a compatible software solution. Information regarding,

Configuration types

Level transmitters can be configured as follows:

- Configuration of the parameters for the lower and upper range values (via Zero and Span push buttons), without an integral HMI using the local push buttons.
- Configuration of the level transmitter using the integral HMI with keypad (menu-controlled)
- Configuration with a handheld terminal
- Configuration using a PC/laptop via the graphical user interface (DTM)

Configuring the transmitter without an integral HMI

LMT Series level transmitters allow local adjustments via the onboard non-intrusive push buttons, when selected. The push buttons are located under the identification nameplate. To gain access to the local adjustments, release the attaching screws on the nameplate and rotate the identification plate clockwise.

⚠ WARNING – Potential damage to parts.

Operating the control buttons with a magnetic screwdriver is not permitted.

The lower range value and span parameters can be set directly on the transmitter, using the external push buttons.

The transmitter is calibrated by the manufacturer, based on the order information. The tag plate contains information on the “lower range value” and the “upper range value” set. In general, the following applies:

LRV and URV configuration (4-20 mA ranging) using local push buttons

- Apply the level for the lower range value and wait until the signal has stabilized.
- Press the “Z” button. This sets the output current to 4 mA.
- Apply the level for the upper range value and wait until the signal has stabilized.
- Press the “S” button. This sets the output current to 20 mA.

If required, reset the damping to its original value.

Record the new settings. The respective parameter is stored in the non-volatile memory 10 seconds after the “Z” or “S” button is pressed.

IMPORTANT NOTE

This configuration procedure only changes the 4-20 mA current signal. It does not affect the physical process level (PV value), also shown on the digital display or user interface. After performing a correction, check the device configuration.

Configuring the transmitter using the optional integral HMI - Through the Glass (TTG) (L2 option)

The integral HMI is connected on the LMT Series communication board. It can be used to visualize the process-measured variables as well as to configure the display and the transmitter.

The TTG technology allows the user to activate the keypad on the HMI without the need of opening the windowed cover of the transmitter. The capacitive pickups detect the presence of the user's finger in front of the respective button, activating the specific command. At the transmitter power-on, the HMI automatically calibrates its sensitivity. It is mandatory for the proper functioning of the TTG HMI that the cover is sufficiently tightened at power-on.

In case the cover has been removed to access the communication board, it is recommended to power off and power on the transmitter once the windowed cover has been set in place and properly tightened.

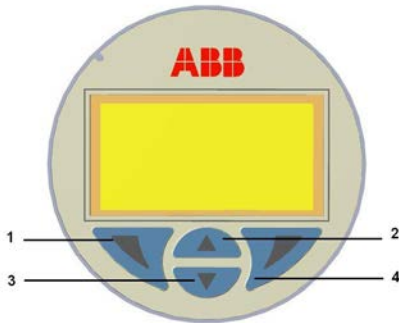

Figure 25 HMI Display Keyboard

The keys (1), (4), (2) and (3) are available for the menu-controlled configuration.

- The menu / sub-menu name is displayed above in the HMI display.
- The number / line of the currently selected menu item is displayed in the upper right of the HMI display.
- A scroll bar is located on the right edge of the HMI display and shows the relative position of the currently selected menu item within the menu.
- Both of the keys (1) and (4) can have various functions. The meaning of these buttons is displayed below in the HMI display above the corresponding button.
- The user can browse through the menu or select a number within a parameter value using both keys (2) and (3). The button (4) selects the preferred menu item.

Commissioning using the Easy Setup Menu

The most common configuration parameters are summarized in the Easy Setup Menu. This menu provides the quickest way to configure the device.

For a detailed description of all of the device menus and parameters, see the Operation section of this manual.

- 1 Log on to the LMT at the Standard or Advanced access level.



- 2 Select Easy Setup in the main menu



- 3 Select a language in the "Easy Setup" menu and press

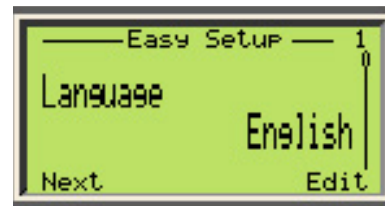

- 4 Select available option of primary variable in the "Easy Setup" menu and press

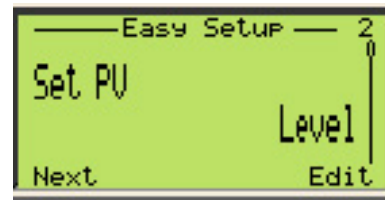

- 5 Select available option of units of measure in the "Easy Setup" menu and press

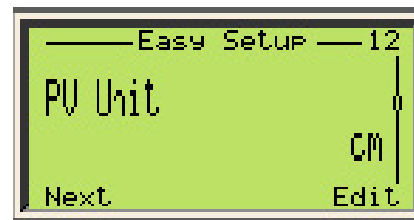

- 6 Set LRV in the "Easy Setup" menu and press

LRV is the lower range value which corresponds to 4 mA current out value



- 7 Set URV in the "Easy Setup" menu and press

URV is the upper range value which corresponds to the 20 mA current out value

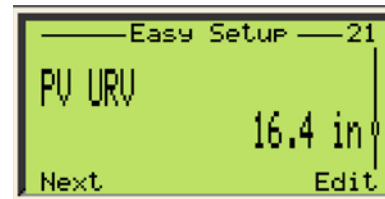

- 8 Set Damping time in the "Easy Setup" menu and press
- Damping allows smoothing step response in the device output.



9 Select displayed variable in the “Easy Setup” menu and press

Sets the selected process variable on the first line on the process display



10 Set a tag in the “Easy Setup” menu and press

A tag is a quick way to identify the device

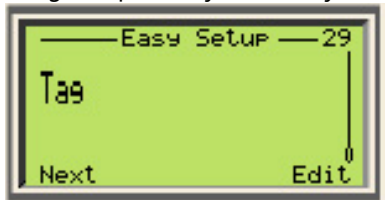

Configuration with the PC/laptop

A graphical user interface (DTM) is required for configuration of the transmitter via PC or laptop. For operating instructions, refer to the software description.

The LMT Series of level transmitters can be configured by either one of the following:

- ABB Asset Vision Basic, a new, free-of-charge software configurator, downloadable at www.abb.com/instrumentation.
- Any DTM-based software for HART instruments; configuration (provided it is compatible with EDD or DTM).

Configuration with the graphical user interface (DTM) – system requirements

- Operating control program (for example, ABB Asset Vision Basic, version 1.00.17 or higher)
- Device Type Manager; graphical user interface (DTM)
- Operating system (depending on the respective control program)

Configuration with a HART handheld terminal

The user can utilize a hand-held terminal to read out or configure / calibrate the transmitter. If a communication resistor is installed in the connected supply unit, the user can clamp the hand-held terminal directly along the 4-20 mA line. If no communication resistor is present (min. 250Ω), the user

needs to install one in the line. The hand-held terminal is connected between the resistor and the transmitter, not between the resistor and the supply unit (see Figure 26 and Figure 27).

Hand-held terminals such as the ABB 691HT, ABB DHH800-MFC, Emerson Process 375 and 475 (provided the LMT Series EDD is downloaded and enabled in the terminal).

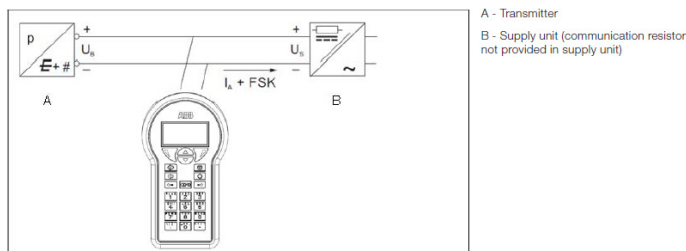

Figure 26 Communication setup with hand-held terminal

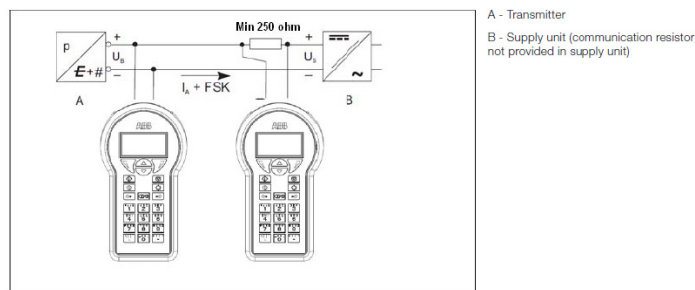

Figure 27 Connection examples with communication resistor in the connection

For additional information, refer to the operating instructions included with the hand-held terminal.

If the transmitter is configured in the factory, according to customer specifications for the measuring point, all the user needs to accomplish is the mounting and wiring of the transmitter, as described. The measuring point is now ready for use.

Each configuration step is subject to a plausibility check. The user can call up context-sensitive help at any time by pressing the “F1” key. Immediately after receiving the transmitter or before changing the configuration, it is recommended to save the existing configuration data to a separate data storage media via the path: “File_Save”.

8 Operation

The HMI display is provided with optional capacitive control buttons. When this option is selected, device control through the glass of the closed cover is enabled.

IMPORTANT NOTE

When the capacitive control button option is selected, the transmitter automatically calibrates the buttons on a regular basis. If the cover should be opened during operation, the button sensitivity is increased at first. As a result, operating errors may occur. The button sensitivity returns to normal during the next automatic calibration.

Menu navigation

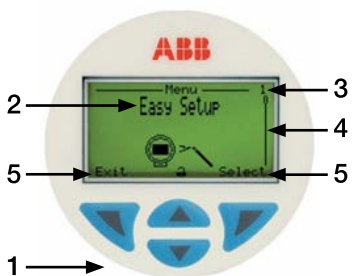





Figure 28 HMI Display

- 1 Display with control buttons for menu navigation
- 2 Menu name
- 3 Menu number
- 4 Marker for indicating relative position within the menu
- 5 Function currently assigned to the  and  control buttons

Control button functions

 Function	Meaning
Exit	Exit the menu
Back	Go back to the upper level menu
Cancel	Cancel a parameter entry
Next	Select the next position for entering numerical and alphanumeric values

 Function	Meaning
Select	Select a submenu or parameter
Edit	Edit a parameter
OK	Save the entry

HMI menu structure

The HMI menu is divided in the following sections and can be selected by using the keys (2) and (3). Once they appear on the display, the sub-menu icon also appears. The user can then confirm their selection with the (4) [SELECT] key. Follow the instructions on the screen to perform the configuration of the various parameters.

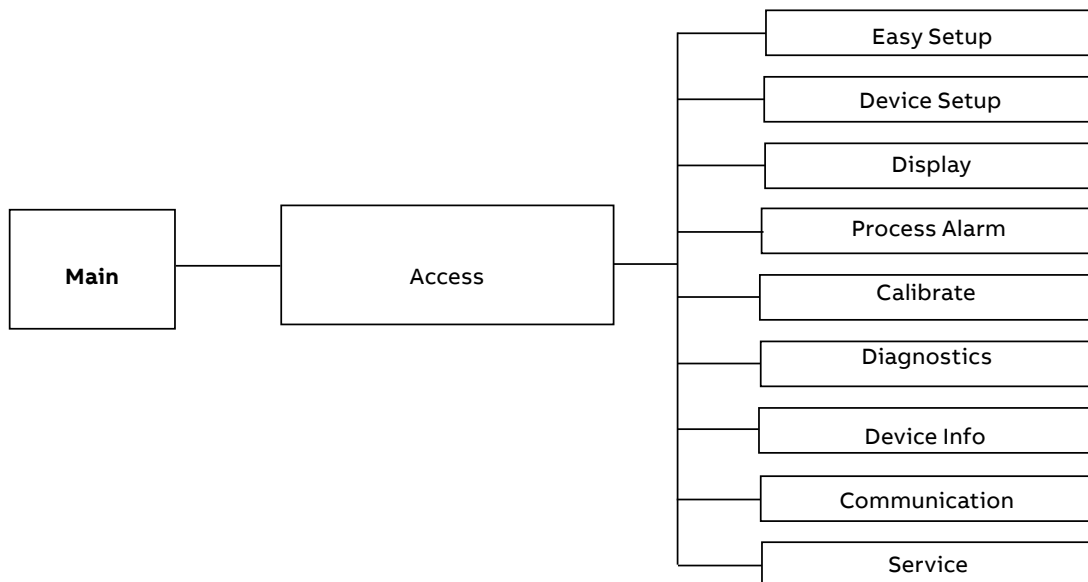

Easy Setup



This menu allows the verification and the setting of parameters for the basic configuration of the LMT Series level transmitters. The menu-driven structure guides the user to the choice of interface language, the tag number configuration, the engineering units, the upper range value and the lower range value (URV and LRV) and the display visualization mode (the value that needs to be visualized on the HMI).

Device Setup

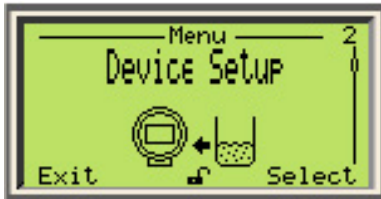

This menu allows the verification and the establishing of parameters related to the whole LMT Series of devices. The menu-driven structure includes enabling write-protection, setting process variables (unit, LRV and URV), selecting transfer functions (linearization type and low flow cutoff) and scaling output (unit according to the measurement and LRV / URV). The last selectable sub-menu allows the user to reset all the parameters to the default configuration.

Display

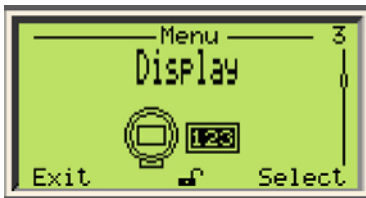

The Display menu allows the setup of different functions relevant to the display itself. The menu-driven structure guides the user through the choice of various functional aspects, such as the display language and contrast. Moreover, it is possible to choose, in detail, what displays on the screen: one or two lines with or without the bar graphs. Inside the menu, there is the possibility of setting a protection password (security) and the display scaling (linearization type, unit, LRV, URV). The display revision number is also available.

Process Alarm



This Alarm menu enables the parameterization of the alarm functions. The menu-driven structure guides the user through the failsafe choices, such as the saturation limits and the fail level (upscale or downscale).

Calibrate



The Calibrate menu allows the local calibration of the instrument. The menu-driven structure allows the user to adjust sensor trimming (low or high) and the output settings (set to 4 or 20 mA).

Diagnostics

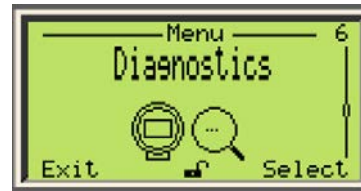

The Diagnostics menu is in place to allow the user to monitor diagnostic messages that relate to the pressure variable, output current, output percentage, scaled output, static and sensor pressure. The menu-driven structure guides the user through the loop test (set 4 and 20 mA and set the output value).

Device Info



The Device Info menu enables the user to retrieve all information about the device. The menu-driven structure shows the user the sensor type, the hardware and software revisions, the high and low sensor limits as well as the minimum applicable span.

Communication



The last section of the structured menu items, the Communication menu allows the user to change the communication tag and the MULTI-DROP mode with HART address numbers for the device. It is also where variables are assigned to HART addresses (PV, SV, TV, QV).

Menu levels

Product display

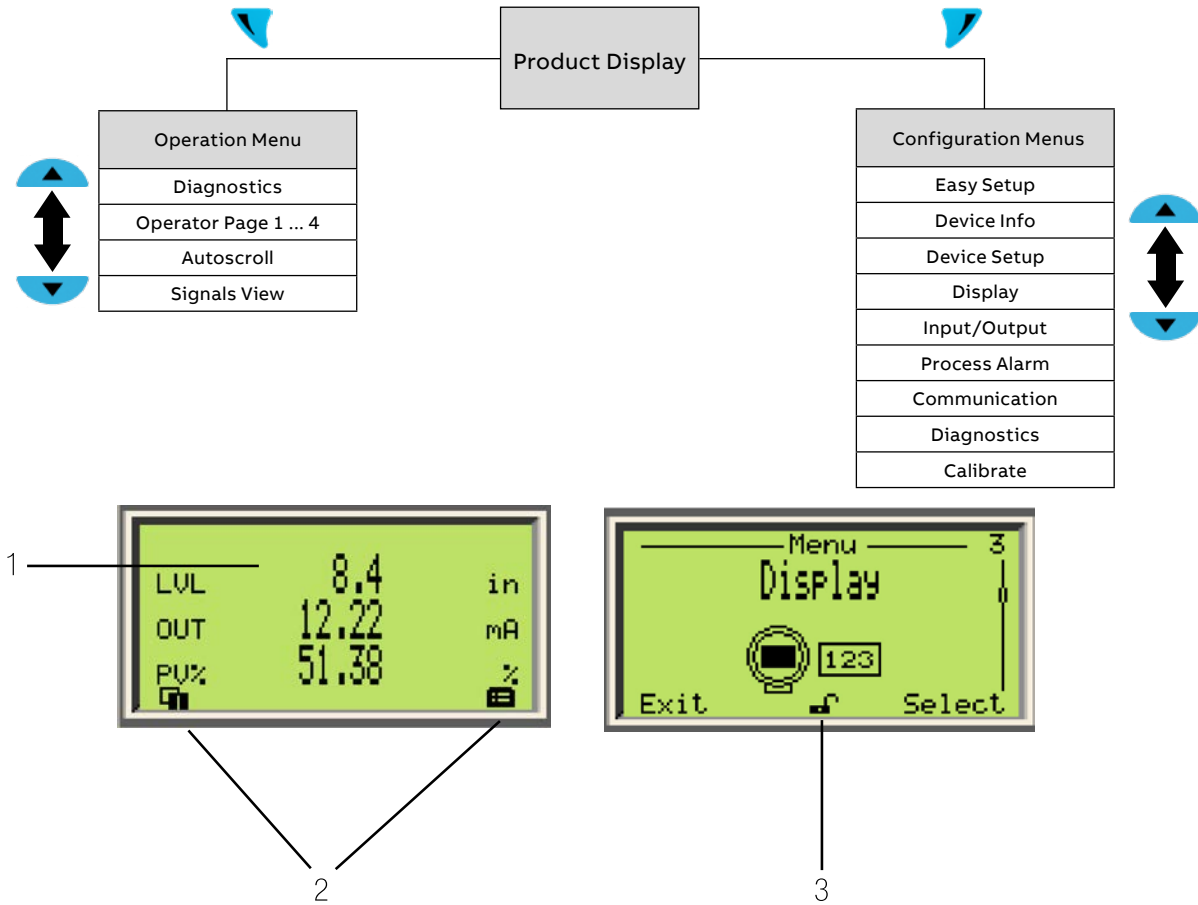

Figure 29 Product Display

- 1 Present process values
- 2 Symbol indication button function
- 3 Area where indicator for “Parameterization protected” state shows

Symbol	Description
	Call up information level
	Call up configuration level
	The device is protected against all changes
	The device allows some changes
	The device allows all changes
	Service access

IMPORTANT NOTE

The HMI display automatically returns to the process display, 5 minutes after the last button is actuated

Switching to operator menu

The operator menu can be used to display diagnostics information and select which operator pages to display.

- 1 Press to switch to the operator menu
- 2 Press or to select a submenu
- 3 Press to confirm your selection

Menu	Description
.../ Operator Menu	Error / Alarm of the electronics
Diagnostics	Error / Alarm of the sensor
Operator Page 1	Select the "Diagnostics submenu" See section 8 "Diagnostic History".
Operator Page 2	Select the operator page to displayed
Operator Page 3	Select the operator page to displayed
Operator Page 4	Select the operator page to displayed
Signals View	Error / Alarm due to the present operating conditions

Area	Description
Electronics	Error / Alarm of the electronics
Sensor	Error / Alarm of the sensor
Status	Alarm due to the present device status
Configuration	Error / Alarm due to the present operating conditions

Invoking the error description

In case of an error, a message consisting of an icon and text appears at the bottom of the process display. The displayed text indicates where the error has occurred.

- 1 Press to switch to the operator menu



- 2 Press or to navigate to select a submenu
- 3 Press to confirm your selection

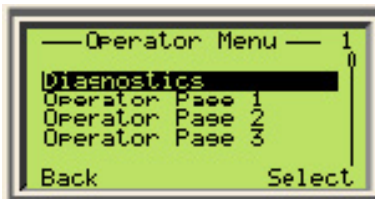

The first line indicates where the error occurred
 The second line shows the unique id.
 The next lines give a brief description of the error and its remedy

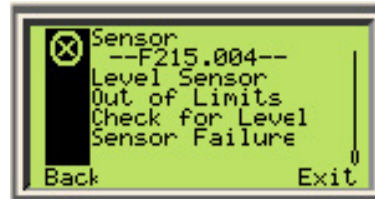

Switching to the configuration level parameter entry

The device parameters can be displayed and changed on the configuration level

- 1 Press to switch to the configuration menu

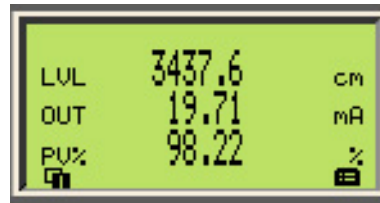

- 2 Press or to select an access level
- 3 Press to confirm your selection



IMPORTANT NOTE

There are four access levels as follows:

- "Read Only" level disables all entries. No parameter can be modified
- "Standard" level can edit some parameters
- "Advanced" level can edit all parameters
- "Service" level is reserved for ABB technician access
 Passwords can be defined for the "Standard" and "Advanced" levels
 Document your password so that it can be retrieved later.

- 4 Enter the corresponding password
- 5 Press to switch to the information level. The HMI display now indicates the first menu item at the configuration level
- 6 Press or to select a menu
- 7 Press to confirm your selection

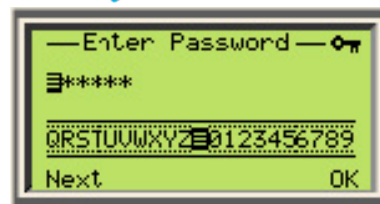

Selecting and changing parameters

Selecting a parameter value

- 1 Select the parameter you want to set in the menu
- 2 Press  to see the list of available parameters values. The parameter value that is currently set is highlighted

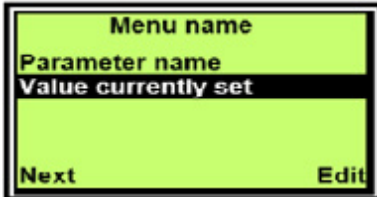

- 3 Press  or  to select the required value
- 4 Press  to confirm your selection

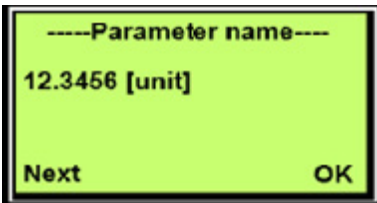

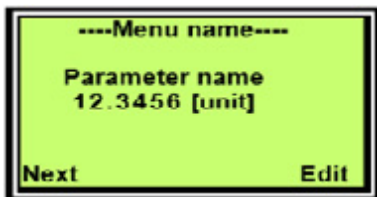

Setting a numerical parameter

- 1 Select the parameter you want to set in the menu
- 2 Press  for parameter editing. The currently selected position is highlighted



Exiting the setup

Values are mandatory for some menu items. Exit a menu without parameter change as follows:

- 1 Press  repeatedly until the cursor reaches the end position. Press  once more to move cursor to lower right corner where "Cancel" will be displayed.
- 2 Press  to terminate editing and exit the menu item.

Menu: Easy Setup



- Language
- Set PV
- PV Unit
- PV LRV
- PV URV
- PV Damping Time
- Display 1 Line 1 View
- Tag

The Easy Setup menu has multiple options that are available to the user. These options are detailed below:

Language

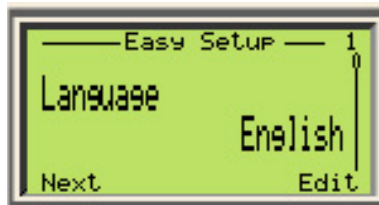

The Language option enables the user to set various operating languages to assist in the setup of the LMT Series transmitter. When a specific language is selected, the titles of the menu items are then converted to the selected language. Abbreviations specific to the LMT Series transmitters remain unchanged as icons, regardless of language selection.

The available languages are as follows:

English	German
French	Spanish
Italian	Russian
Chinese	Portuguese

Set PV (Primary Variable)

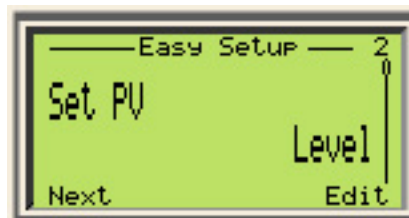

The Set PV option allows the user to select the PV (Primary Variable) to Level, Distance/Ullage or Interface if the device is configured for two levels.

PV Unit

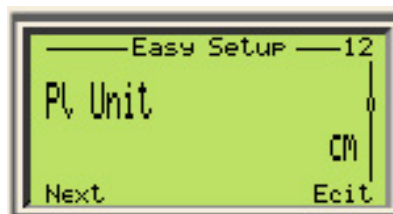

The PV Units option allows the user to select the unit of measure for the process variable of the unit and provide a basis for all of the setup functions. Selectable engineering units include: inches, feet, meters, centimeters and millimeters.

PV LRV



The PV LRV stands for the lower range value and is a value in engineering units that determines at which measured value the LMT Series transmitters generate an output. Traditionally, this is referred to as the zero point. From the factory, the PV LRV is set to 0.00 inches.

PV URV



The PV URV is the upper range value in engineering units which signifies what measured value the LMT Series transmitter will generate as an output. This is generally known as the span point.

PV Damping Time



Damping is a setting designed to delay the output response to a change in the measured level. If the process is agitated or splashing of the liquid is a possibility, a higher damping value may be required. If the process changes rapidly, a lower damping value may be needed to improve the response time to a level change. The highest damping allowable is 60 seconds.

Display 1 Line1 View



The display line can be set to Level, Distance/Ullage and Interface if the device is configured for two levels. The graph can be set to display % span or % mA value.

Tag

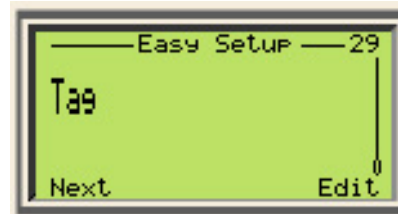

The tag parameter is the final step in Easy Setup. It simply allows the operator to add the device tag or another memo in the device tag menu.

Menu: Easy Setup (continued)

Menu/Parameter	Value Range	Description
Easy Setup		
Language	English, Chinese, Portuguese, German, Spanish, French, Italian	Menu language options.
Set PV	Level, Interface, Distance/Ullage, Volume Level, Volume Interface, Flow	Select device variable where applicable which will be assigned to the 4-20 mA output and HART primary variable.
PV Unit	<ul style="list-style-type: none"> • Unit length <ul style="list-style-type: none"> - mm, cm, m, in, ft • Unit volume <ul style="list-style-type: none"> - Liters, Cubic meters, cubic inches, cubic feet, cubic yards, gallons, Imperial gallons, bushels, barrels, liquid barrels • Unit flow <ul style="list-style-type: none"> - Liters/second, liters/minute, liters/hour, gallons/second, gallons/minute, gallons/hour, gallons/day, imperial gallons/second, imperial gallons/minute, imperial gallons/hour, imperial gallons/day, barrels/second, barrels/minute, barrels/hour, barrels/day, cubic meters/second, cubic meters/minute, cubic meters/hour, cubic meters/day, cubic feet/second, cubic feet/minute, cubic feet/hour, cubic feet/day 	Defines unit of measure for primary variable.
PV LRV	Non linearized Minus 10% to half of probe length Linearized -999999999 to 999999999	Sets 4 mA output point which is also the lower range value of the measuring span.
PV URV	Non-linearized Half to 20% beyond probe length Linearized -999999999 to 999999999	Sets 20 mA output point which is also the upper range value for the measuring span.
PV Damping Time	0.1 - 60 seconds	Allows signal smoothing of the 4-20 mA signal.
Display 1 Line 1 View	Level, Interface, Distance/Ullage	Select variable to be viewed on display.
Tag	alphanumeric	User defined. 32 characters available.

Menu: Device Setup

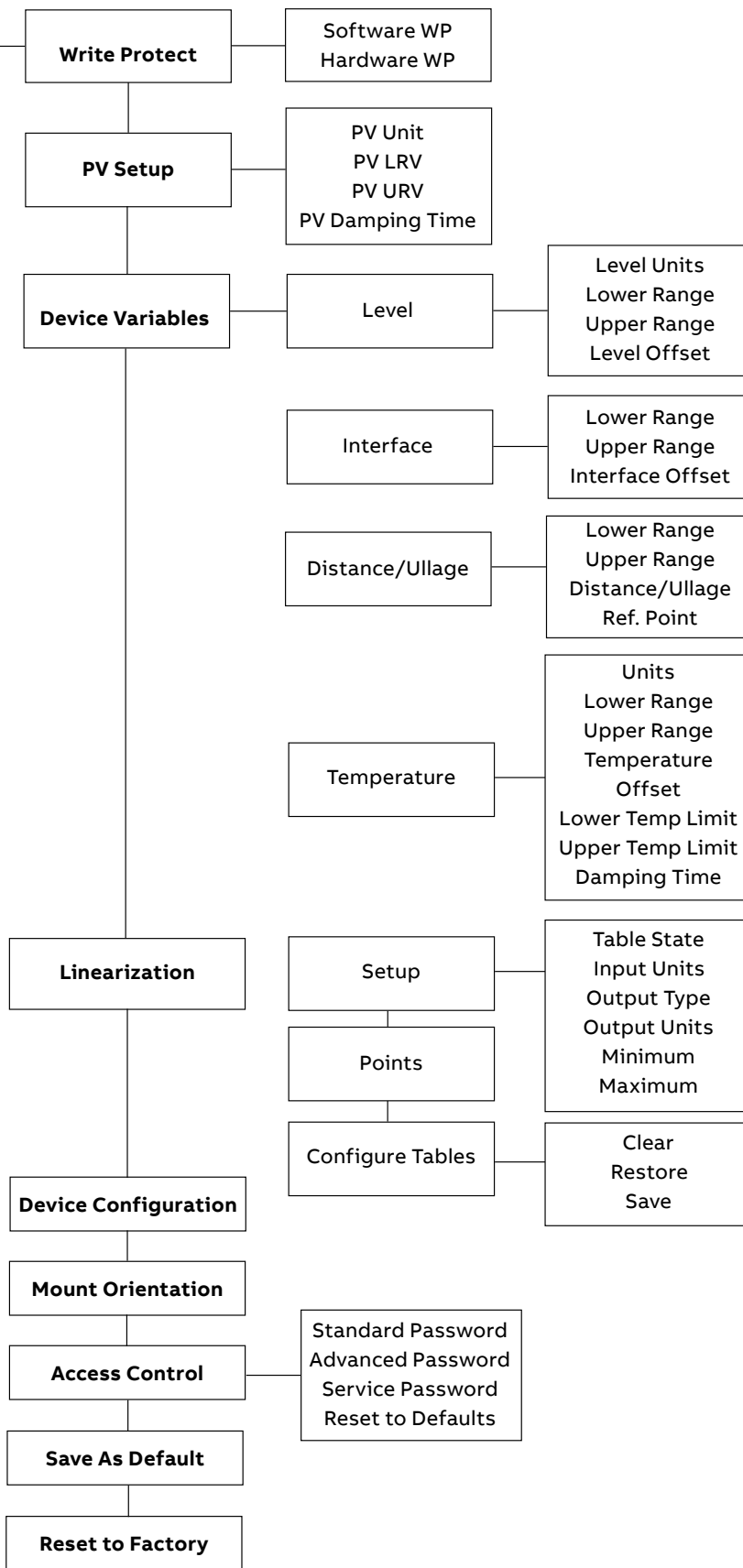

Menu: Device Setup (continued)

Menu/Parameter	Value Range	Description
Device Setup/Write Protect		
Software WP	On, Off	Sets ability of user to edit parameters through software
Hardware WP	Unlocked, Locked	Sets ability of user to edit parameters through mechanical switch on the top of the transmitter housing
Device Setup/PV Setup		
PV Unit	<ul style="list-style-type: none"> • Unit length <ul style="list-style-type: none"> - mm, cm, m, in, ft • Unit volume <ul style="list-style-type: none"> - Liters, Cubic meters, cubic inches, cubic feet, cubic yards, gallons, Imperial gallons, bushels, barrels, liquid barrels • Unit flow <ul style="list-style-type: none"> - Liters/second, liters/minute, liters/ hour, gallons/second, gallons/minute, gallons/hour, gallons/day, imperial gallons/ second, imperial gallons/minute, imperial gallons/ hour, imperial gallons/day, barrels/ second, barrels/minutes, barrels/ hour, barrels/day, cubic meters/second, cubic meters/ minute, cubic meters/hour, cubic meters/day, cubic feet/second, cubic feet/minute, cubic feet/hour, cubic feet/day 	Defines unit of measure for primary variable
PV LRV	<ul style="list-style-type: none"> • Non linearized <ul style="list-style-type: none"> - Minus 20% to 120% of probe length • Linearized <ul style="list-style-type: none"> -999999999 to 999999999 	Sets 4 mA output point which is also the lower range value of the measuring span.
PV URV	<ul style="list-style-type: none"> • Non linearized <ul style="list-style-type: none"> - Minus 20% to 120% of probe length • Linearized <ul style="list-style-type: none"> -999999999 to 999999999 	Sets 20 mA output point which is also the upper range value for the measuring span.
PV Damping Time	0.1 – 60 seconds	Allows signal smoothing of the 4-20 mA signal.
Device Setup/Device Variables/Level		
Level Units	mm, cm, m, in, ft	Sets units for level output type
Lower Range	<ul style="list-style-type: none"> • Non linearized <ul style="list-style-type: none"> - Minus 20% to 120% of probe length • Linearized <ul style="list-style-type: none"> -999999999 to 999999999 	
Upper Range	<ul style="list-style-type: none"> • Non linearized <ul style="list-style-type: none"> - Minus 20% to 120% of probe length • Linearized <ul style="list-style-type: none"> -999999999 to 999999999 	
PV Offset	+/- 50% of probe length	
Device Setup/Device Variables/Interface		
Lower Range	<ul style="list-style-type: none"> • Non linearized <ul style="list-style-type: none"> - Minus 20% to 120% of probe length • Linearized <ul style="list-style-type: none"> -999999999 to 999999999 	
Damping Time	0.1-60 seconds	
Upper Range	<ul style="list-style-type: none"> • Non linearized <ul style="list-style-type: none"> - Minus 20% to 120% of probe length • Linearized <ul style="list-style-type: none"> -999999999 to 999999999 	
Interface Offset	+/- 50% of probe length	
Device Setup/Device Variables/Temperature	C, F	select temperature unit of measure
Lower Range	-200°C to 300°C	
Upper Range	-200°C to 300°C	
Temperature Offset	-200°C to 300°C	
Lower Temp Limit	-200°C to 300°C	
Upper Temp Limit	-200°C to 300°C	

Menu: Device Setup (continued)

Menu/Parameter	Value Range	Description
Device Setup/Device Variables/Volume Level		
Lower Range	-999999999 to 999999999	
Upper Range	-999999999 to 999999999	
Device Setup/Device Variables/Volume Interface		
Lower Range	-999999999 to 999999999	
Upper Range	-999999999 to 999999999	
Device Setup/Device Variables/Flow		
Lower Range	-999999999 to 999999999	
Upper Range	-999999999 to 999999999	
Device Setup/Linearization/Setup		
Table State	Enabled, Disable	
Input Units	mm, cm, m, in, fit	
Output Type	Level, volume, flow	
Output Units	<ul style="list-style-type: none"> • Unit length <ul style="list-style-type: none"> - mm, cm, m, in, ft • Unit volume <ul style="list-style-type: none"> - Liters, Cubic meters, cubic inches, cubic feet, cubic yards, gallons, Imperial gallons, bushels, barrels, liquid barrels • Unit flow <ul style="list-style-type: none"> - Liters/second, liters/minute, liters/hour, gallons/second, gallons/minute, gallons/ hour, gallons/day, imperial gallons/ second, imperial gallons/minute, imperial gallons/hour, imperial gallons/day, barrels/second, barrels/minutes, barrels/ hour, barrels/day, cubic meters/second, cubic meters/minute, cubic meters/hour, cubic meters/day, cubic feet/second, cubic feet/minute, cubic feet/hour, cubic feet/day 	
Minimum	-999999999 to 999999999	
Maximum	-999999999 to 999999999	
Device Setup/Linearization/Points		
0-20	Input Point Output Point Enable/Disable	
Device Setup/Linearization/Configure Tables		
Clear		
Save		
Restore		
Device Setup/Device Configuration		
Device Configuration	1 Level 1 Level with Temperature 2 Levels 2 Levels with Temperature	
Device Setup/Mount Orientation		
Mount Orientation	Top, Bottom	This is the mounting orientation of the sensor
Device Setup/Access Control		
Standard Password	Alphanumeric	User defined
Advanced Password	Alphanumeric	User defined
Service Password	Restricted	Restricted
Reset to Defaults		
Save as default		
Reset to factory		

Damping

Level transmitter outputs signals which are noisy as a result of the process can be smoothed (damped) electrically. Damping is a setting designed to delay the mA output response to a change in measured level. If the process is agitated or splashing of the liquid is possible, a higher damping value may be required. If the process changes rapidly, a lower damping value may be needed to increase the response time to a level change.

Damping can be described as the time responsiveness of the device to the change in measured level. The relationship between damping to changes in input can be described in the following formula where A equals change in measurement signal, τ equals time and equals the damping value

$$A(\tau) = A*(1-2.71828-t/\tau)$$

From this equation a table and graph can be derived to illustrate the delay in reaction time due to changes in the damping value

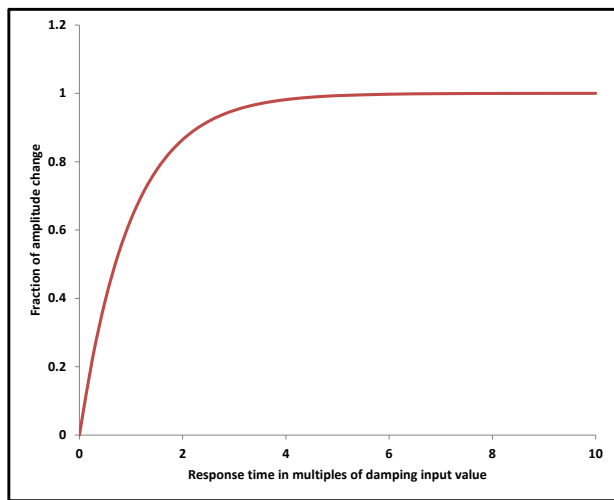

Time Multiplier	1 τ	2 τ	3 τ	4 τ
% of Input Value	0.63	0.86	0.95	0.98

Figure 30 Damping

The additional time constant can be set between 0.1 seconds and 60 seconds in increments of 0.1 seconds. Damping does not affect the value shown on the digital display as a physical unit. Damping only affects the parameters derived from it, such as analog output current, free-process variable, input signal for the controller and so forth. The damping adjustment can be performed through the HMI display or DTM or handheld terminal.

Damping adjustment through HMI display

Level transmitter outputs signals which are noisy as a result of the process can be smoothed (damped) electrically.

- 1 Enter the menu: Device Setup
- 2 Press to select PV Setup
- 3 Press to confirm the selection



- 4 Press to select PV Damping time
- 5 Press to confirm the selection

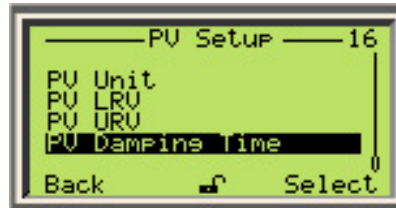

- 6 Press to edit the PV Damping Time



Overview of the linearization/strapping tables

Linearization is an approximation to a function at a given point. The LMT has 21 linearization points available for implementing up to 20 segments of linear calibration.

Linearization allows significant improvements of the accuracy of the measurement in tanks and vessels with irregular shapes where otherwise the resulting PV calculation would not meet the expected accuracy due to the non-linear function between the level in the tank and the resulting PV.

For effective use of the multipoint calibration using linearization tables is important to understand the advantages that it provides and the limitation of its use.

Typically, there is need for linearization/strapping tables when the user intends to use Volume or Flow as the PV and the application is in tanks and vessels with irregular shapes where the function between the level in the tank and the resulting PV is non-linear.

Practical use of linearization/strapping table

Assuming for example that Volume will be used as the PV in tanks with shape as shown in the pictures below, only two points need to be enabled in the linearization/strapping table. The reason for this is that the Volume is a linear function of the Level being measured. In both cases, the volume is equal to the factor of the area of the base of the tank by the liquid level.

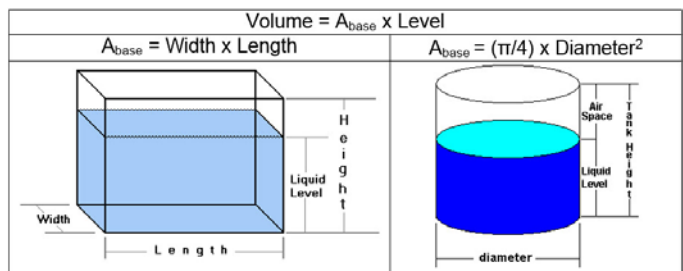

Figure 31 Tank Volume Calculation

When volume is a linear function of the level, the Level can be isolated as result of a factorization. In these cases, the calculated PV could be considered as accurate as the accuracy of the level measurement.

Cylindrical tanks are very common and the type described in Figure 32 most of the times only requires two linearization points because the volume is a linear function of the measured level and can be easily implemented from the formula: $A_L = \pi R^2$, $V = A_L \times \text{Level}$ unless internal features of the tank like pipes running through, agitators, entry ports, nozzles, etc... affect the relationship between the volume and the measured level move beyond the accuracy of the volume calculation outside of the acceptable range. Some of the features mentioned above can either decrease or increase the volume.

Calculation of the volume of fluid in a partially filled tank sometimes represent a challenging calculation. For many applications, the use of linearization tables allows overcoming the challenge but in some others cases the calculation must be deferred to the Control System to be able to use complex formulas.

Cylindrical tank in horizontal position are also very common in the industry but unlike its relative in vertical position the partial volume is not a linear function of the measured level. Below is an example for calculating partial volume in such a tank:

Volume of liquid in a tank on its side

$A_L = \text{Area of liquid}$

$A_L = \text{Area of circle} - \text{Area of a Sector} + \text{Area of triangle}$

$$A_L = \pi R^2 - R^2 \arccos\left[\frac{(R-h)}{R}\right] + (R-h)\sqrt{2Rh-h^2}$$

R = radius of tank

h = distance from top of tank to surface of liquid

Volume of liquid

$$V = A_L \times \text{length of tank}$$

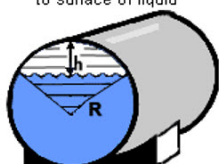

Figure 32 Tank Volume Calculation

The figure 33 shows the chart for the plot of Level (mm) vs. Volume (m3) for the tank in figure 32

Diameter = 1000 mm & Length = 2500 mm

The plot in blue shows the ideal characteristic as calculated for an infinite number of points. The plot in red shows the Volume output from a transmitter using a 2-point (1-segment) linearization/strapping table with linearization points are 0 and 1000 mm. The plot in green shows an output characteristic using a 6-point (5-segment) linearization/strapping table with linearization points at 0, 200 mm, 400 mm, 600 mm, 800 mm & 1000 mm.

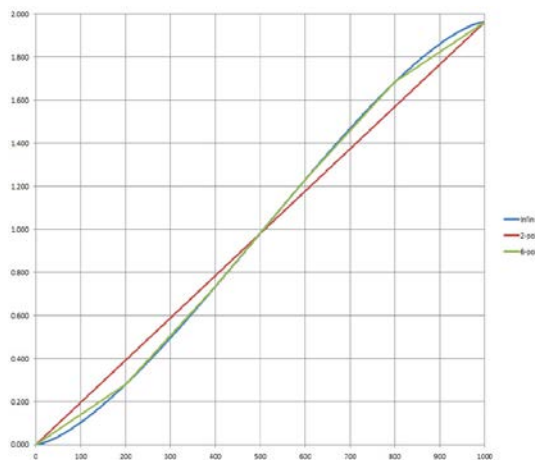

Figure 33 Level vs Volume - 2 Point Strapping

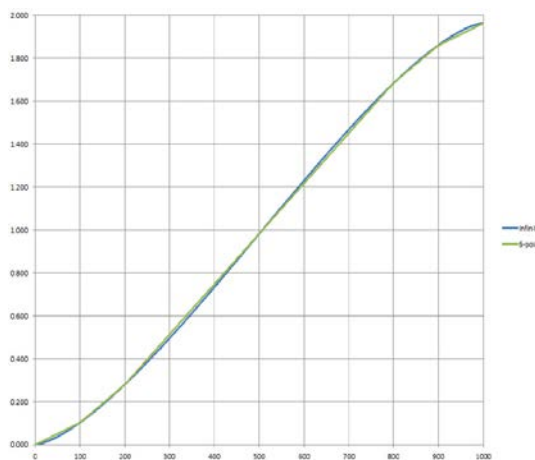

Figure 34 Level vs Volume - Multi-Point Strapping

From Figure 34 we can see the following:

- The accuracy of the linearization increases with the number of points. More points, more accuracy.
- The characteristic of the volume vs level measured gets closer to linear in the center of the tank. Choosing the points strategically can improve the accuracy of the measurement. Per se, we could set most of the points closer to the bottom and top of the tank as follow: 0 mm, 100 mm, 200 mm, 800 mm, 900 mm & 1000 mm.

For example use the tank in 8.6.2.1-2, where the Diameter is 1000 mm, Length is 2500 mm, Input Unit is mm, Output type is Volume, Output unit is liters

Point #	00	01	02	03	04	20
Input Value <In> (mm)	0	100	200	800	900	1000
Output Value <Out> (lit)	0	102.19	279.56	1683.94	1861.31	1963.5

Using linearization tables

STEP 1:

Log in as an “Advanced user by pressing 



STEP 2:

Press  to navigate to Device Setup menu

Press  to Select/Enter the Device Setup menu



STEP 3:

Press  to navigate to Linearization submenu

Press  to Select/Enter the Linearization menu



IMPORTANT NOTE

All parameters in the following section are edited the same unless otherwise stated***

Configuring Setup

STEP 1:

Press  or  to highlight setup

Press  to Select/enter into the Linearization setup menu

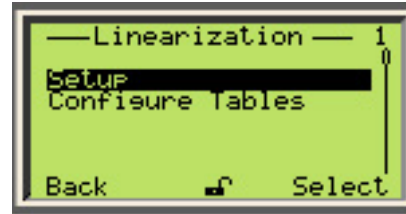

STEP 2:

Press  to Select/enter into the Table State menu



STEP 3:

Press  to edit the Table State





STEP 4:

Press  or  to highlight an action

Press  to apply the highlighted action





IMPORTANT NOTE

After the Table State is enabled other menus become visible in the Linearization Setup menu but there is no need to go back to the root menu, instead it is possible to navigate to another submenu using the  or  keys. For example, when inside the Table State submenu will jump directly to Input Units submenu. If the  key is pressed again it will take you inside the Output Type submenu.

STEP 5:

Press  to get to Input Units menu

Press  to edit Input Units

Press  or  to select the desired input unit. We recommend using the same unit type used already for level

Press  to OK/confirm the selection

Press  to go back to Linearization Setup menu

**IMPORTANT NOTE**

Input units are only level values. Linearization input units are independent of PV units.

STEP 6:

Press  to get to Output Type menu

Press  to edit the Output Type

Press  or  to select the output type

Press  to OK/confirm selection

Press  to go back to Linearization Setup menu

**IMPORTANT NOTE**

Options are Level, Volume, Flow depending of device configuration

STEP 7:

Press  to get to Output Units menu

Press  to edit the Output unit

Press  or  to select the Output unit

Press  to OK/confirm selection

Press  to go back to Linearization Setup menu

**IMPORTANT NOTE**



Output units are based on output type and do not change the PV output units

STEP 8:

Press  to get to Minimum menu

Press  to edit minimum value for the output

Press  to scroll to proper digit

Press  or  to value of the highlighted digit



Press  to confirm the minimum value for the output

**STEP 9:**

Press  to get to Maximum menu

Press  to edit maximum value for the output

Press  to scroll to proper digit

Press  or  to value of the highlighted digit

Press  to confirm the maximum value for the output



Editing Points

STEP 1:

From Linearization menu, press or to get to Points submenu

Press to Select/Enter the points submenu

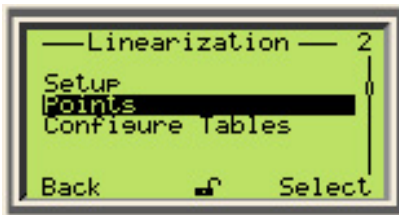

IMPORTANT NOTE

Linearization points menu description

- 1 Current linearization point number (could be 00 – 20).
- 2 Current level being measured
- 3 Input Value for the current selected point
- 4 Output Value for the current selected point

- The scroll function accessed by pressing the key allows navigation
- between the point number “00”, the Input Value <In>, or the Output Value <Out>.
- To change between points, press or . When at “00” only can be used, when at point “20” only can be used, and for any other points or can be used.
- To edit the input or output value of the points press the key when <In> or <Out> are highlighted respectively.

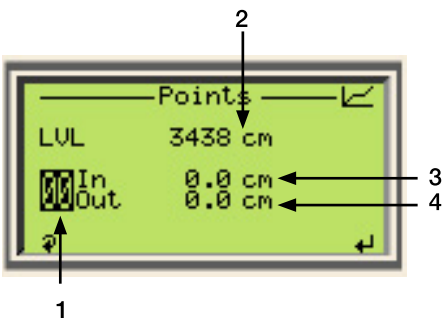

STEP 2:

Press to highlight point number, if not already highlighted

Press or to navigate to other point numbers

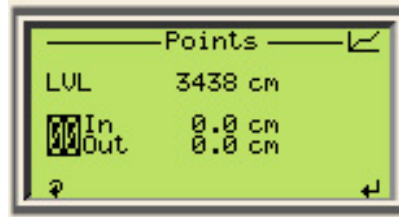

STEP 3:

Press to scroll to the Input value <In>

There are two methods to edit:

- a Press to “capture” the current level value (LVL) and assign it to the input value of this point
- b Press to manually enter in value

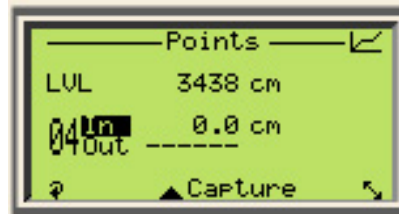

STEP 4:

Press to scroll to Output value <Out>

Press to enable the point

Press to edit the output value of the point



STEP 5:

Press to scroll to Output value <Out>

Press to enable the point

Press to edit the output value of the point

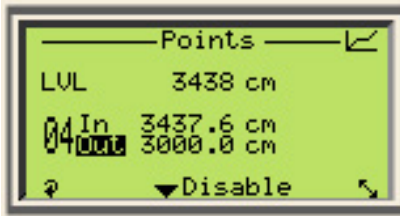

Repeat Step 2-5 to enable and assign input and output values for other points.

IMPORTANT NOTE

At least 2 points must be used, but 2 points will be the same as standard calibration unless the purpose is to use Volume or Flow as PV.

Menu: Display

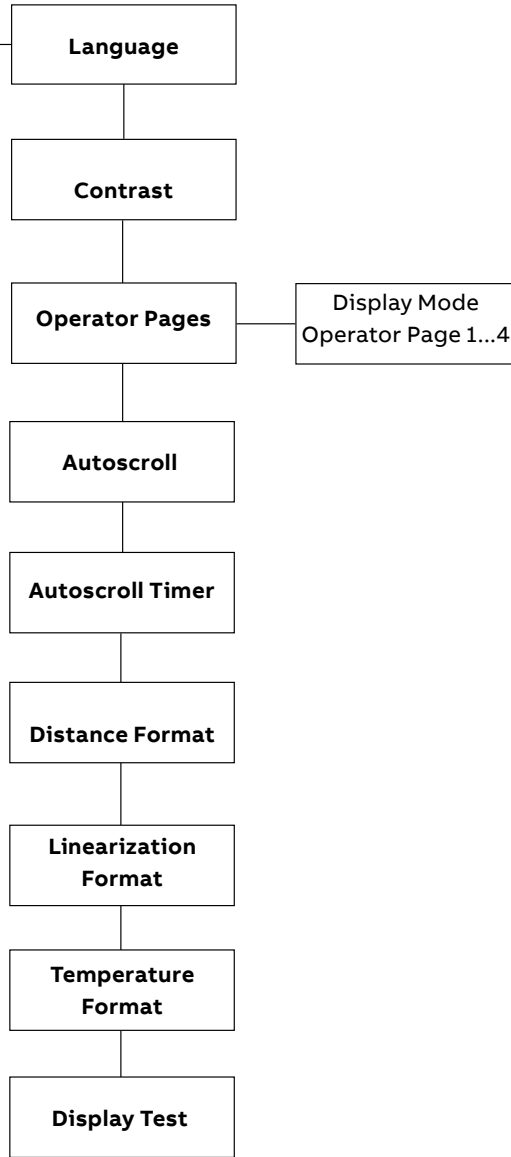
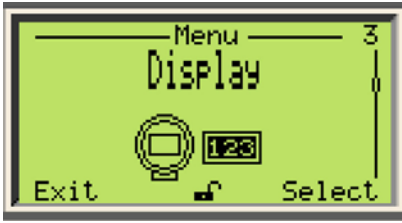

Menu: Display (continued)

Menu/Parameter	Value Range	Description
Display/Language		
Language	English, Chinese, Portuguese, German, Spanish, French, Italian	Menu language
Display/Contrast		
Contrast	0-100	Sets contrast of display
Display/Operator Pages/Operator Page 1		
Display Mode	mm, cm, m, in, ft	Sets units for level output type
Lower Range	1x6 1x6 + Graph 1x9 2x9 2x9 + Graph 3x9	Configure each operator page
1 st Line	Signal	Configure each line
2 nd Line	Signal	Configure each line
3 rd Line	Signal	Configure each line
Display/Operator Pages/Operator Pages 2..4		
Display Mode	-	Configure each operator page
1 st Line	-	Configure each line
2 nd Line	-	Configure each line
3 rd Line	-	Configure each line
Display/Autoscroll		
Autoscroll	Enabled/Disabled	Enable or disable autoscroll functionality
Display/Autoscroll Timer		
Autoscroll Timer	5,7,10,15,30 seconds 1,2,3,4,5 minutes	Time between scrolling of screens
Display/Distance Format		
Display Format	X X.X X.XX X.XXX	Precision of decimal places for non linearized device variables and signals
Display/Linearization Format		
	X X.X X.XX X.XXX	Precision of decimal place for linearized device variables
Display/Temperature Format		
	X X.X X.XX X.XXX	Precision of decimal places for Temperature
Display/Display Test		
Display Test		Checks proper functioning of display

Menu: Process Alarm

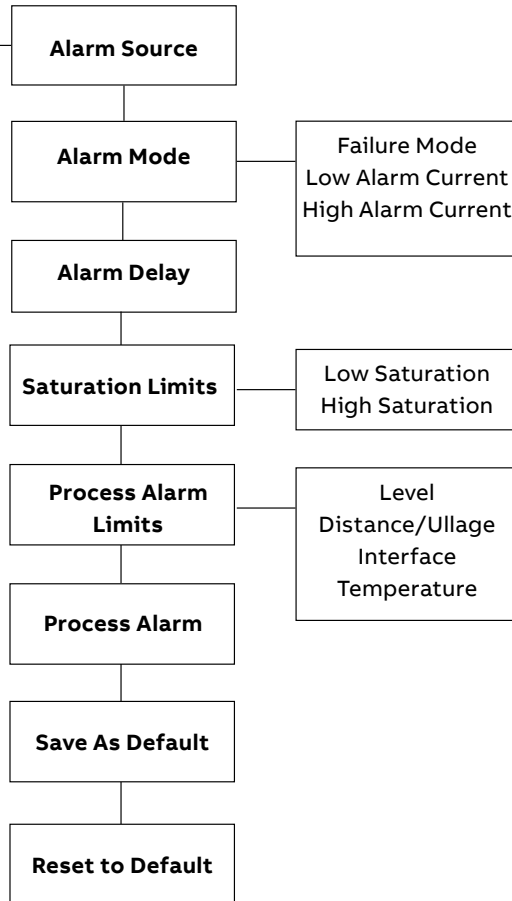
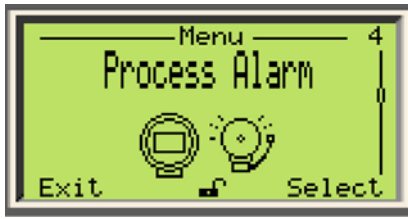

Menu: Process Alarm (continued)

Menu/Parameter	Value Range	Description
Process Alarm/Alarm Source		
Alarm Source	Software, Hardware	Indicates from where alarms are set
Process Alarm/Alarm Mode/Failure Mode		
	High, Low	Sets which direction to drive current when in alarm
Process Alarm/Alarm Mode/Low Alarm Current		
Low Alarm Current	3.5 - 3.8 mA	Value of current set when in low alarm
Process Alarm/Alarm Mode/High Alarm Current		
High Alarm Current	20.5 - 22 mA	Value of current set when in high alarm
Process Alarm/Process Alarm Limits/Level		
Level	Low Low Low High High High	Alarms set at different points of process range for Level. Signal available via HMI and HART protocol.
Process Alarm/Process Alarm Limits/Distance Ullage		
Distance/Ullage	Low Low Low High High High	Alarms set at different points of process range for Distance/Ullage. Signal available via HMI and HART protocol.
Process Alarm/Process Alarm Limits/Interface		
Interface	Low Low Low High High High	Alarms set at different points of process range for Interface. Only applicable in 2 Levels and 2 Levels with Temperature device configuration. Signal available via HMI and HART protocol.
Process Alarm/Process Alarm Limits/Temperature		
Temperature	Low Low Low High High High	Alarms set at different points of process range for Temperature. Only applicable if device configuration has temperature. Signal available via HMI and HART protocol.

Menu: Calibrate

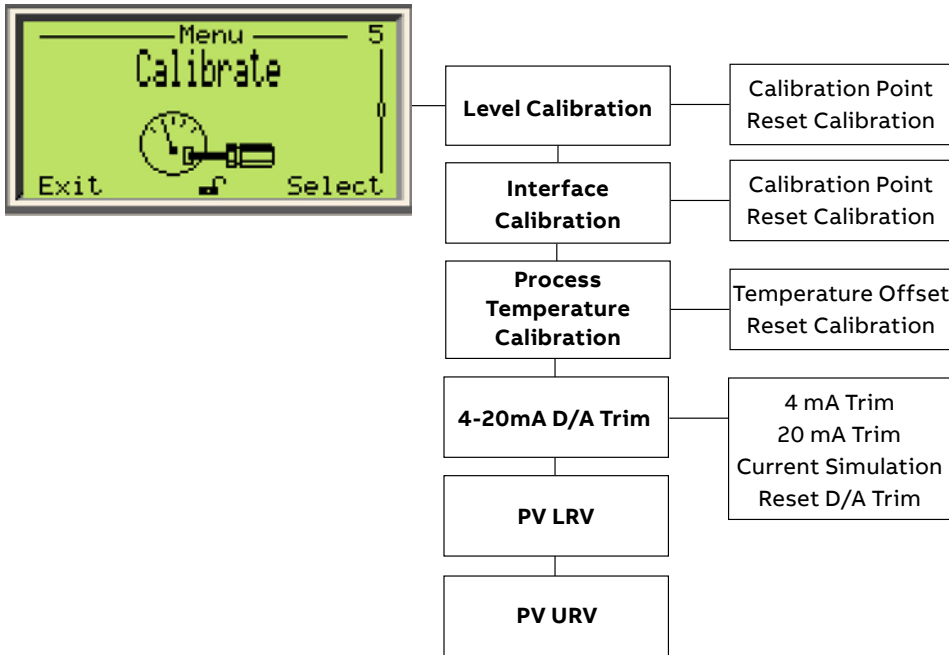

Menu/Parameter	Value Range	Description
Level Calibration		
Calibration Points	'Out' values range must be within 5% of the 'In' values range.	SVL – Sensor value at Level Points – Corresponds to points 00 and 01 In – Sensor value Out – Level value
Reset Calibration		Resets calibration points to factory defaults
Interface Calibration		
Calibration Points	'Out' values range must be within 5% of the 'In' values range.	SVI – Sensor value at Interface Points – Corresponds to points 00 and 01 In – Sensor value Out – Level value
Reset Calibration		Resets calibration points to factory defaults
Process Temp Calibration		
Temperature Offset		
Reset Calibration		Resets calibration to factory defaults
4-20 mA D/A Trim		
4 mA Trim	4 mA	Sets current to 4 mA
20 mA Trim	20 mA	Sets current to 20 mA
Current Simulatation	3.5-23.6 mA	Sets current to user defined value
Reset D/A Trim		Reset trim to factory defaults

Level Calibration

The LMT Series is a digital transmitter with no routine calibration or reconfiguration required. If a recalibration is required, this can be done using the HART signal (via DTM, EDDL) or with the menu driven HMI display.

The most important term to understand and master the calibration process is the Sensor Value (SVL). SVL could be seen from two perspectives:

- Technical – SVL is the output parameter of the factory trim, which gets mapped to the propagation time.
- Practical – The SVL could be interpreted as the “Raw” Level before any user specific calibration is applied to the instrument, and its values always increases in the direction to the tip of the probe, independently of the mounting orientation.

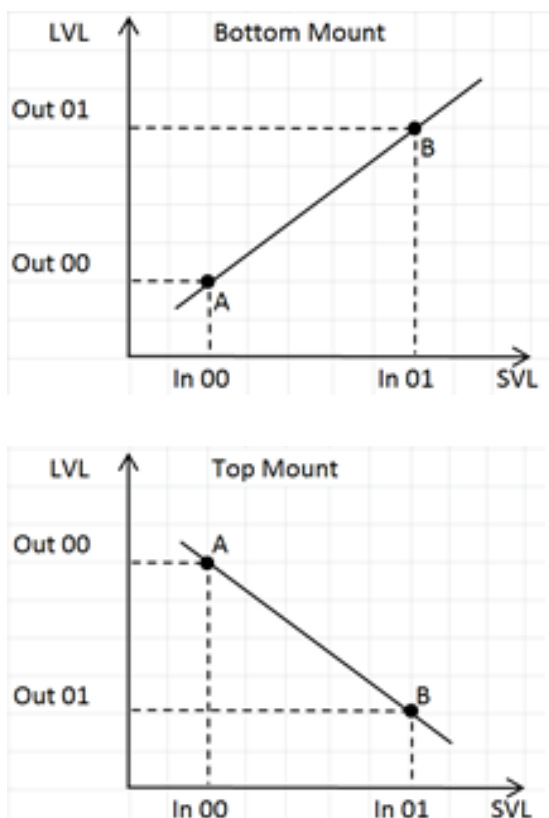

Figure 35 Bottom & Top Mount Charts

In other words, the SVL could be seen as the level output of the instrument based only on the factory trim. After the factory trim the SVL at any given point on the probe will remain unchanged for the life of the instrument (unless trimmed again at later time) and it is not affected by any level calibration, offset or linearization applied by the user.

Notice that Calibration Point 00 is always located above Calibration Point 01, which means Point 00 always corresponds to “HIGHER” level value than Point 01.

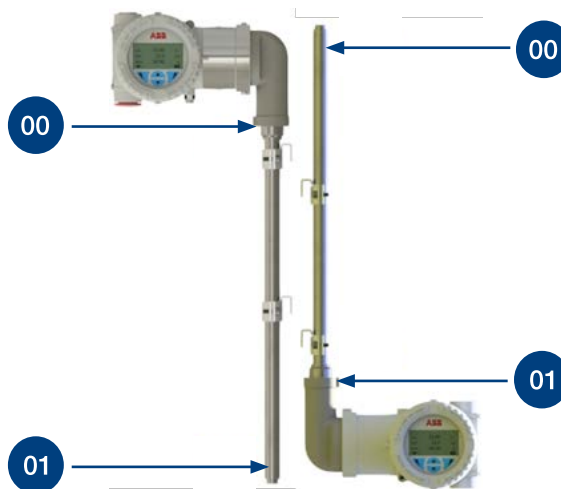

Figure 36 Calibration Points

By default after the trim the SVL & LVL are aligned at the calibration points 00 & 01 matching each other values but during the Level Calibration SVL could be mapped to different Level Values (LVL) that don't violate the validation rule for Level calibration: The LVL span must be within $\pm 5\%$ the SVL span.

LMT Calibration through HMI

STEP 1:

From the “Level Information” screen press to switch to the “Access Level” menu

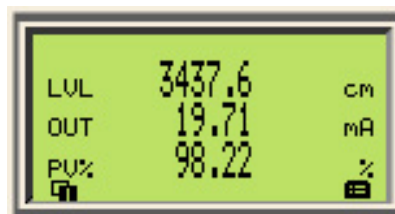

STEP 2:

Press or to navigate to “Advanced”

Press “Select”



STEP 3:

Press or to navigate to the Calibrate menu

Press “Select” to enter the menu



STEP 4:

Press or to get to "Level Calibration" menu

Press "Select" to enter the menu

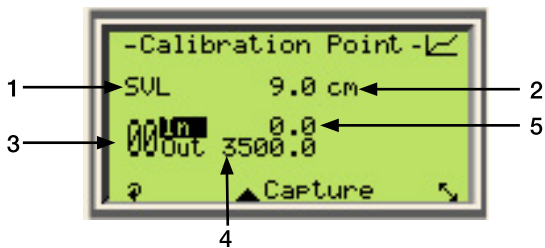
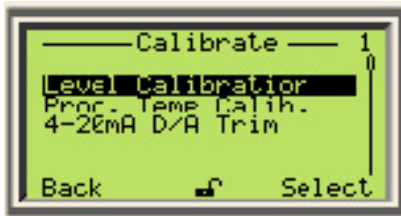

IMPORTANT NOTE

Calibration points menu description

- 1 Sensor Value label
- 2 Current sensor value is the raw factory level being measured currently
- 3 Calibration point index (options 00 & 01)
- 4 Level value (LVL) or output value of the cal. point
- 5 Sensor value (SVL) or input value of the cal. point

- The scroll function accessed by pressing the key allows navigation between the point number "00", the Input Value <In>, or the Output Value <Out>.
- To change between points, press when "00" is highlighted or when "01" is highlighted.
- To edit the input or output value of the points press the key when <In> or <Out> are highlighted respectively.

STEP 5:

Press to scroll the cursor to <In>, which corresponds to the input value of point 00. For wet calibration the float must be at the position where the cal. Point 00 is wanted. Press to capture the Current SVL and apply it to the input value of the point.



STEP 6:

Alternatively to Step 5, for dry calibration, when the float or level cannot be moved to the desired position for point 00 press <right> to edit the input value.

Press to scroll from one digit to another

Press or keys to edit each digit.

Press to complete this operation and OK/accept the input value.



STEP 7:

Press to scroll the cursor to <Out>

Press to edit the output value. To edit the Output Value of point 00 use the same operations as in step Step 6



STEP 8:

Press to scroll the cursor to the point selection.

Press key to select point 01.

Repeat the operations in steps 5-7 to set the Input and Output Values for point 01

The steps above could be repeated for any of the 2 points if additional fine adjustment is needed.

NOTICE: The order in which the points are set is irrelevant.

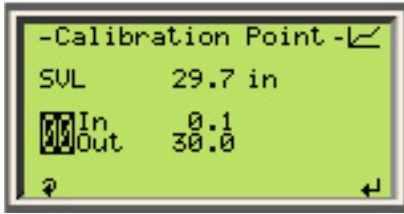

To exit the calibration menu press to scroll until either point 00 or 01 is highlighted and then to exit the calibration and return to the previous menu.

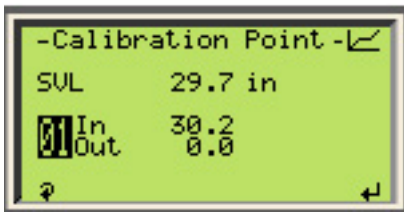

Calibration examples

1 Use of validation rule for Level Calibration

In the examples below the Input span is 100 – 0 = 100cm, as such Output span must be between 95 and 105 cm ('Out' values range must be within 5% of the 'In' values range).

Examples of acceptable calibration:

Top Mount		Case 1	Case 2	Case 3	Case 4
Point	In	Out	Out	Out	Out
00	0 ->	0	15	25	0
01	100 ->	100	115	130	95

Examples of rejected calibration:

Bottom Mount		Case 4	Case 5
Point	In	LVL	LVL
00	100 ->	94	116
01	0 ->	0	10

2 Calibration moving float to both 0 and 100% points (Wet Calibration)

Requirements	<ul style="list-style-type: none"> Probe Length = 220 cm Mounting: Bottom or Top ML = 200 cm
Procedure	<ul style="list-style-type: none"> Place the float at 0% Capture sensor value (SVL) to assign it to <In> of point 01 Set 0 cm for <Out> of point 01 Place the float at 100% Capture SVL to assign it to <In> of point 00 Set 200 cm for <Out> of point 00 End

3 Calibration moving float only to 0% point only (Partially Wet calibration)

Conditions	<ul style="list-style-type: none"> Probe Length = 220 cm Mounting: Bottom or Top ML = 200 cm
Procedure	<ul style="list-style-type: none"> Place the float at 0% Capture sensor value (SVL) assign it to <In> of point 01 Set 0 cm for <Out> of point 01 Take the <In> of point 01 and add 200 cm for bottom mount transmitters or subtract 200 cm for top mounted transmitters. Ex: if <In> of point 01 of top mounted unit was 210.5 cm then <In> for point 00 will be 10.5 cm Use the resulting sum for <In> of point 00 Set 200 cm for parameter <Out> of point 00 End

4 Calibration stretching the zero beyond trim points

Conditions	<ul style="list-style-type: none"> LMT200 Probe Length = 220 cm Mounting: Top ML = 200 cm
Procedure	<ul style="list-style-type: none"> Determine the lower point to measure. Place the float in that position and inspect the signal in the waveform screen to make sure that there is enough signal amplitude, that is not merging with the end of the probe. Back off from that position until the signal is not merging with the end of the probe and the amplitude is the same as in the beginning of the probe Measure the distance from the desired zero mark. Capture SVL for parameter <In> of point 01 Set the measured distance for parameter <Out> of point 01 Place the float at 100% Capture SVL for parameter <In> of point 00 Set 200 cm for parameter <Out> of point 00 End

5 Calibration when float cannot be moved to 0% or 100% points (Dry Calibration)

Conditions	<ul style="list-style-type: none"> Probe Length = 220 cm Mounting: Bottom or Top ML = 200 cm Current level 35%
Procedure	<ul style="list-style-type: none"> Capture SVL for parameter <In> of point 01 Set parameter <Out> of point 01 to 70 cm (35%) Take the <In> parameter of point 01 and add 130 cm (remaining 65%) for bottom mount units or subtract 130 cm for top mounted units. Use the resulting sum for parameter <In> of point 00 Set 200 cm for parameter <Out> of point 00 End

6 Changing mount orientation

Conditions	<ul style="list-style-type: none"> LMT200 Probe Length = 220 cm Mounting: Bottom or Top ML = 200 cm Previously calibrated for specific mount
------------	---

-
- | | |
|-----------|---|
| Procedure | <ul style="list-style-type: none">• Record the current Level Value before the mounting change.• Change the mounting from Top to Bottom or vice versa.• Change the Signal Polarity in the Diagnostic Menu (typically Standard for bottom mount and Reversed for top mount)• If the points were just swapped and kept in the same position (point 00 became point 01 and vice versa), the level indicated might deviate between 2-3 mm from what was read in the original mounting orientation but if the the points were physically displaced up or down the deviation might be larger.• Calculate the deviation of the level reading between previous and new mounting.• There are two ways to handle this:<ul style="list-style-type: none">- Edit parameter <Out> of both points 00 & 01 to add the determined deviation- Apply Offset. Notice that when the Offset is used it leaves behind the LRV & URV, which need to be set again.• End |
|-----------|---|
-

Menu: Diagnostics

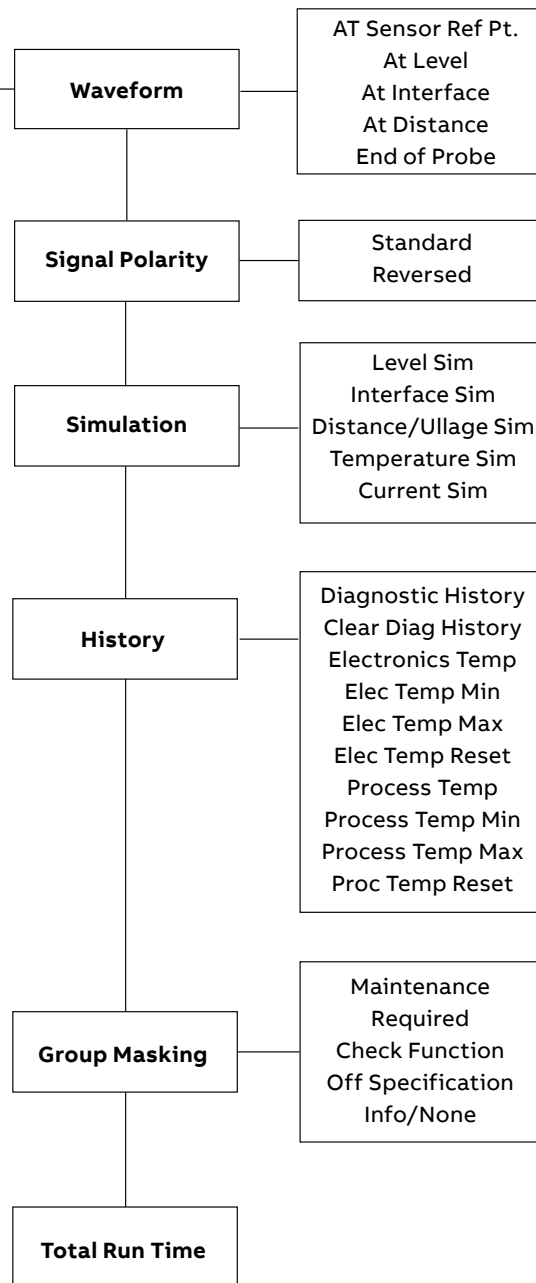

Menu: Diagnostics (continued)

Menu/Parameter	Value Range	Description
Diagnostics/Waveform/At Sensor Ref Pt		
At Sensor Ref Point		Sets waveform screen at Sensor Reference Point
Diagnostics/Waveform/At Level		
At Level		Sets waveform screen at Level position
Diagnostics/Waveform/At Interface		
At Interface		Sets waveform screen at Interface position
Diagnostics/Waveform/At Distance/Distance		
Distance		Sets user defined distance
Diagnostics/Waveform/At Distance/Waveform		
Waveform	Graphical representation of signal	Activate waveform at user defined distance
Diagnostics/Waveform/End of Probe		
End of probe		Sets waveform at end of probe
Diagnostics/Signal Polarity		
Signal Polarity	Standard, Flipped	Sets orientation of waveform peak
Diagnostics/Simulation/Level Sim/Enable		
Enable	Enable, Disable	Enable or disable level value simulation
Diagnostics/Simulation/Level Sim/Level-Sim		
Level-Sim	Level value in selected units	Enable or disable level value simulation
Diagnostics/Simulation/Interface Sim/Enable		
Enable	Enable, Disable	Enable or disable Interface value simulation
Diagnostics/Simulation/Interface Sim/Interface-Sim		
Interface-Sim	Interface value is selected units	User defined Interface value
Diagnostics/Simulation/Distance-Ullage Sim/Enable		
Enable		Enable or disable Distance/Ullage value simulation
Diagnostics/Simulation/Distance-Ullage Sim/Distance- Ullage-Sim		
Distance-Ullage-Sim		User defined Distance/Ullage value
Diagnostics/Simulation/Temperature Sim/Enable		
Enable	Enable, Disable	Enable or disable Temperature value simulation
Diagnostics/Simulation/Temperature Sim/ Temperature-Sim		
Temperature-Sim		User defined Temperature value
Diagnostics/History/Diagnostic History		
Diagnostics History		Gives diagnostic error type, id, name, occurrences, total active time, and time since last occurrence
Diagnostics/History/Clear Diag History		
Clear Diag History		Clears diagnostic history
Diagnostics/History/Electronics Temperature		
Electronics Temperature		Gives current temperature of electronics board
Diagnostics/History/Elec Temp Min		
Elec Temp Minimum		Gives minimum recorded temperature of electronics board
Diagnostics/History/Elec Temp Max		
Elec Temp Maximum		Gives maximum recorded temperature of electronics board
Diagnostics/History/Elec Temp Reset		
Elec Temp Reset		Erases recorded temperature values of electronics board
Diagnostics/History/Process Temp		
Process Temp		Gives current temperature of process only applicable when device equipped with sensor RTD

Menu: Diagnostics (continued)

Menu/Parameter	Value Range	Description
Diagnostics/History/Process Temp Min		
Process Temp Min		Gives minimum recorded temperature of process
Diagnostics/History/Process Temp Max		
Process Temp Max		Gives maximum recorded temperature of process
Diagnostics/History/Proc Temp Reset		
Proc Temp Reset		Resets process temperature
Diagnostics/Group Masking/Maintenance Required		
Maintenance Required	Enable, Disable	Enable or disable diagnostics that fall under this category
Diagnostics/Group Masking/Check Function		
Check Function	Enable, Disable	Enable or disable diagnostics that fall under this category
Diagnostics/Group Masking/Off Specification		
Off Specification	Enable, Disable	Enable or disable diagnostics that fall under this category
Diagnostics/Group Masking/Info None		
Info/None	Enable, Disable	Enable or disable diagnostics that fall under this category
Diagnostics/Total Run Time		
Total Run Time	Days	Gives total time unit has been operating

Waveform display

The LMT series includes an integrated graphic display with waveform screens that detail signal activity. The waveform display of the LMT series is a very useful tool for configuration, diagnostic and troubleshooting of the device.

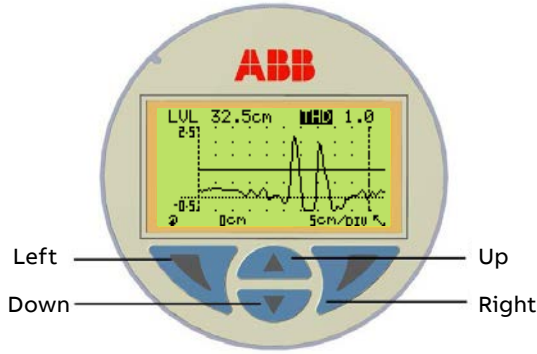

Symbol	Description
	Back to previous menu
	Scroll to next parameter on this screen
	Edit highlighted parameter

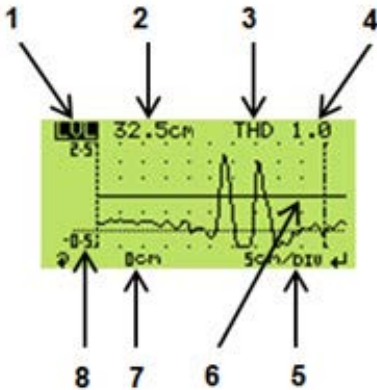

Figure 37 Waveform Display

1 Process value label, which could be one of the following:

- LVL – Level
- INT – Interface
- PV% – Process Value in percentage
- SVL – Sensor Value for Level
- SVI – Sensor Value for Interface

2 Value of the parameter selected in item 1

3 Device measurement parameters. This give access to the following 3 parameters:

- THD – Threshold
- PLS – Pulse Width
- BLK – Blanking

4 Value of the parameter selected in item 3

5 Scale of the waveform screen currently displayed, choices are one of the following:

- For metric units - 5 cm/DIV, 10 cm/DIV, 20 cm/DIV or 40 cm/DIV
- For imperial units – 3 in/DIV, 6 in/DIV, 12 in/DIV or 24 in/DIV

6 Graphical representation of the threshold level.

7 Offset setting reflects the location in the probe (in raw engineering units) from which the signal is displayed and corresponds to the most left side of the waveform plot.

- The scroll function accessed by pressing the key allows navigation between items 1, 3, 5, & 7.
- When the cursor is in positions 5 or 7 press or to change its values.
- When the cursor is in position 3 press or to navigate between threshold, pulse width & blanking, and press in any of those parameters to change its values.
- Press key when positions 1 or 5 are highlighted to exit the waveform screen.

8 The starting reference voltage value

Accessing the Waveform Screen through LMT HMI

STEP 1:

From the “Level Information“ screen press to switch to the “Access Level“ menu

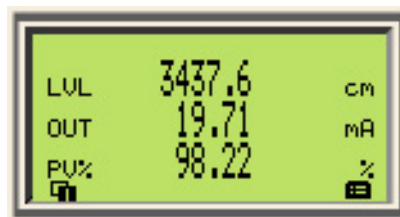



STEP 2:

Press or to navigate to “Advanced”

Press “Select”





STEP 3:

Press  or  to navigate to the Diagnostic menu

Press "Select"  to enter the menu





STEP 4:

Press  or  to get to "Waveform" menu

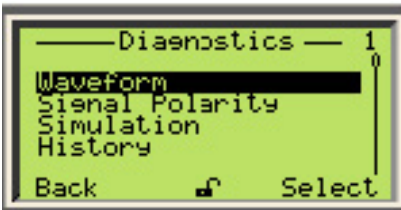
Press "Select"  to enter the menu



STEP 5:

Press  or  to get to the desired position of the waveform



Press "Select"  to enter the waveform screen

**IMPORTANT NOTE**

- At Sensor Ref Pt. displays the signal starting from the beginning of the probe, which is the same as from the enclosure down.
- "At Level" displays the signal with the Level position centered in the screen, unless other limit factors apply but in any case the level position should be visible in the screen.
- "At Distance" displays the signal starting from the distance specified by the user. The Level position must be centered in the screen, unless other limit factors apply but in any case the level position should be visible in the screen.
- "End of Probe" displays the signal the tip of the probe.

Review or Edit device measurement parameters**THRESHOLD:**

Press  to scroll the cursor to the device measurement parameters.

Press  or  keys to select THD (threshold).

Press  to edit the threshold value.

Press  to scroll from one digit to another

Press  or  keys to edit each digit.

Press  to complete this operation and OK/accept the input value.

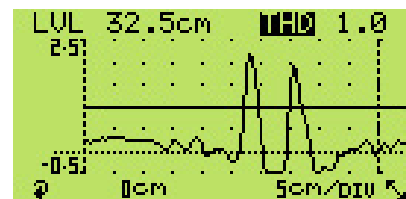
**PULSE WIDTH:**

Press  and  keys to select PLS (pulse width).



Press  to edit the PLS value.

Press  to scroll from one digit to another

Press  or  keys to edit each digit.

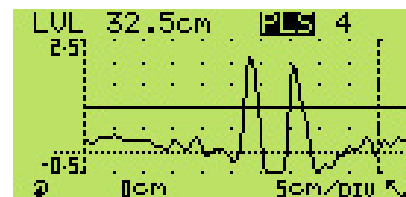
Press  to complete this operation and OK/accept the input value.

**BLANKING / BLOCKING DISTANCE:**

Press  or  keys to select BLK (Blanking Distance).

Press  to edit the BLK value.

Press  to scroll from one digit to another

Press  or  keys to edit each digit.

Press  to complete this operation and OK/accept the input value.

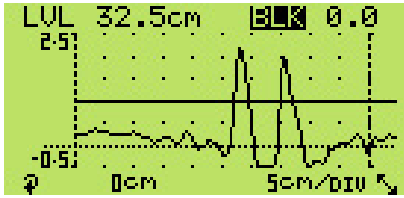

Managing horizontal scales of the waveform



STEP 1:

Press  to scroll the cursor to the offset setting.

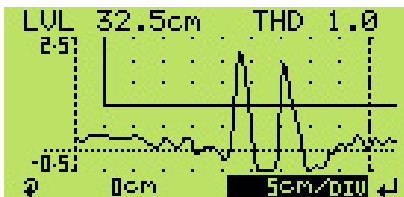
Press  key to increase the horizontal offset to start displaying the signal from a point further down the length of the probe.



STEP 2:

Press  to increase the horizontal scale or  to reduce it.

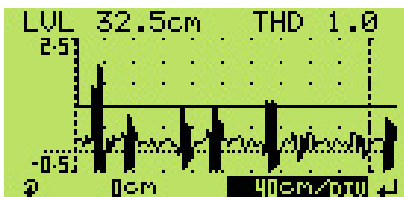
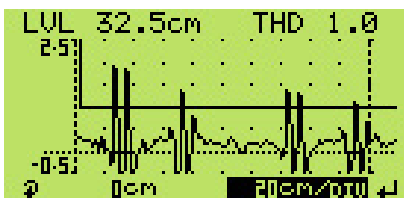
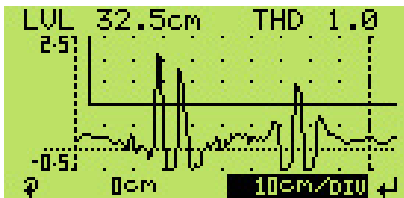



IMPORTANT NOTE

- Notice that if the scale selected covers more than the length of the probe then the navigation to larger scale will be rejected because the selected one already covers everything that is to display.
- Notice that after reaching the upper scale pressing the  key will rollover to the lowest scale

Managing the horizontal offset of the waveform



STEP 1:

Press  to scroll the cursor to the offset setting.

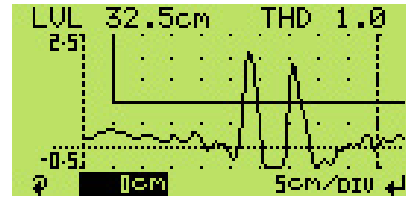
Press  key to increase the horizontal offset to start displaying the signal from a point further down the length of the probe.



STEP 2:

Press  to increase the horizontal offset or  to reduce it.

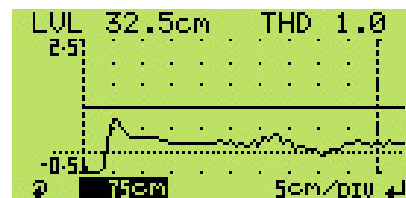
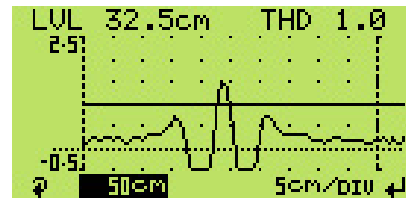
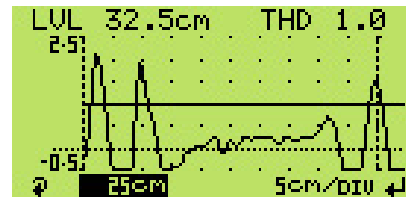

IMPORTANT NOTE

- Notice that if with the selected offset the screen covers more than the length of the probe then the navigation to larger offset will be rejected because the selected one already covers everything that is to display.

Troubleshooting using waveform display

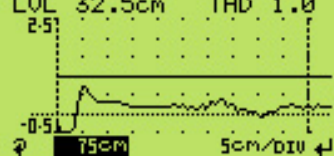
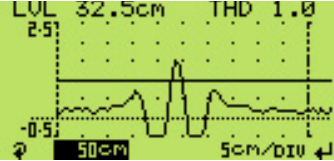
Error	Possible Cause	Suggested Action
 <p>The presence of dashed lines in place of the process variable value</p>	<p>Indicates that a valid level cannot be detected.</p>	<ul style="list-style-type: none"> • Navigate to the waveform screen to verify the presence of a signal with amplitude equal or close to 2V unless the probe length exceeds 20 feet. • Verify that the float is not damaged • Make sure the blanking value does not exceed the signal to be detected • Make sure the threshold is not set too high
 <p>Small amplitude of the signal</p>	<p>Degradation of the signal amplitude could be an indication of other underlying problems like weakening of the magnetic flux of the float or sensor deterioration issues.</p>	<p>If the signal is present but the amplitude does not cross the threshold line verify that:</p> <ul style="list-style-type: none"> • The float is present and not damaged • The strength of the magnetic field of the float is correct. <p>The sensor has deteriorated or been damaged navigate to the pulse width parameter to change it to a larger value.</p> <ul style="list-style-type: none"> • This temporary remedy might give enough time to perform a deeper evaluation of the instrument and replace defective components.
 <p>The float is moving along the probe as well as the signal but the level does not change</p>	<p>Artifacts could be created as result of magnetic materials or components in the proximity of the probe.</p>	<p>Check for artifacts with amplitude larger than the threshold value located on the left side of the signal.</p> <ul style="list-style-type: none"> • Adjust the blanking to bypass the artifacts seen in the waveform screen

Menu: Device Info

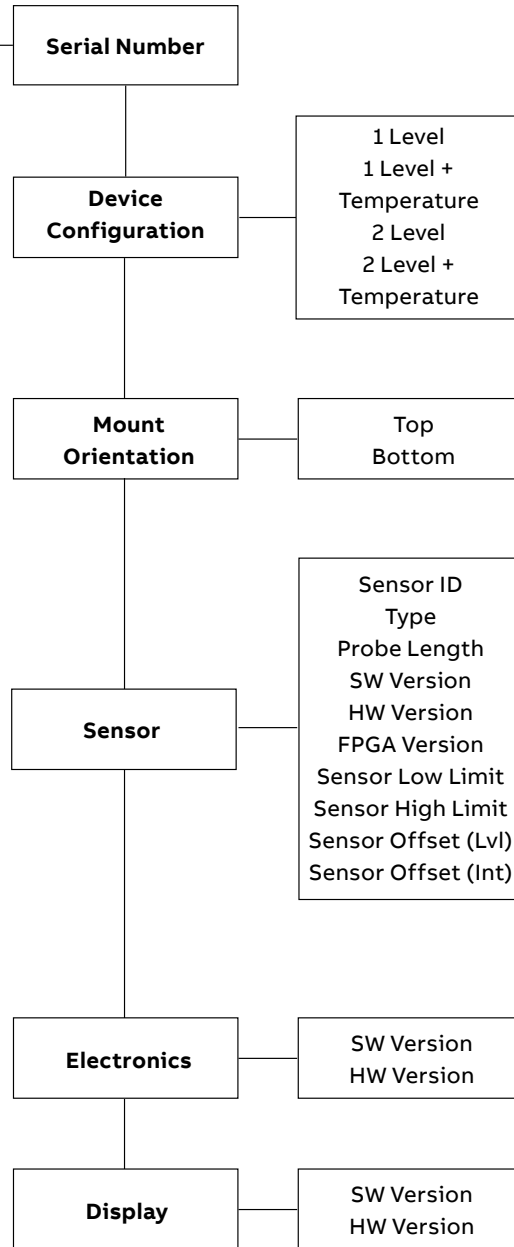
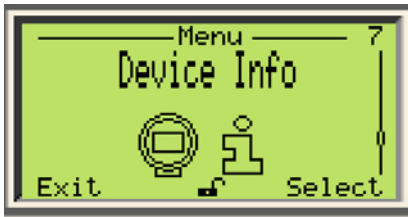

Menu: Device Info (continued)

Menu/Parameter	Value Range	Description
Serial Number		
Serial Number	14 digit Alphanumeric value 3K78	Indicates specific device identification number
Device Configuration		
Device Configuration	1 Level 1 Level + Temperature 2 Levels 2 Levels + Temperature Default: 1 Level	Defines the application use of the device, users can change the measurement from single level to two levels. However, if the device is not equipped with an RTD, then the temperature option will not be available.
Mount Orientation		
Mount Orientation	Top, Bottom Default: Top	Physical mounting position of housing to probe.
Sensor		
Sensor ID	ABB FE01	
Type	Magnetostrictive	Device technology
Probe Length	0-3500 cm	
SW Version	xx.xx.xx	
HW Version	xx.xx.xx	
FPGA Version	xx.xx.xx	
Sensor Low Limit	-0.2 * probe length Default: -700.0 cm	
Sensor High Limit	1.2 * probe length Default: 4200.0 cm	
Sensor Offset	Default: 0.0 cm	
Electronics		
SW Version	xx.xx.xx	
HW Version	xx.xx.xx	
Display		
SW Version	xx.xx.xx	
HW Version	xx.xx.xx	

Menu: Communication

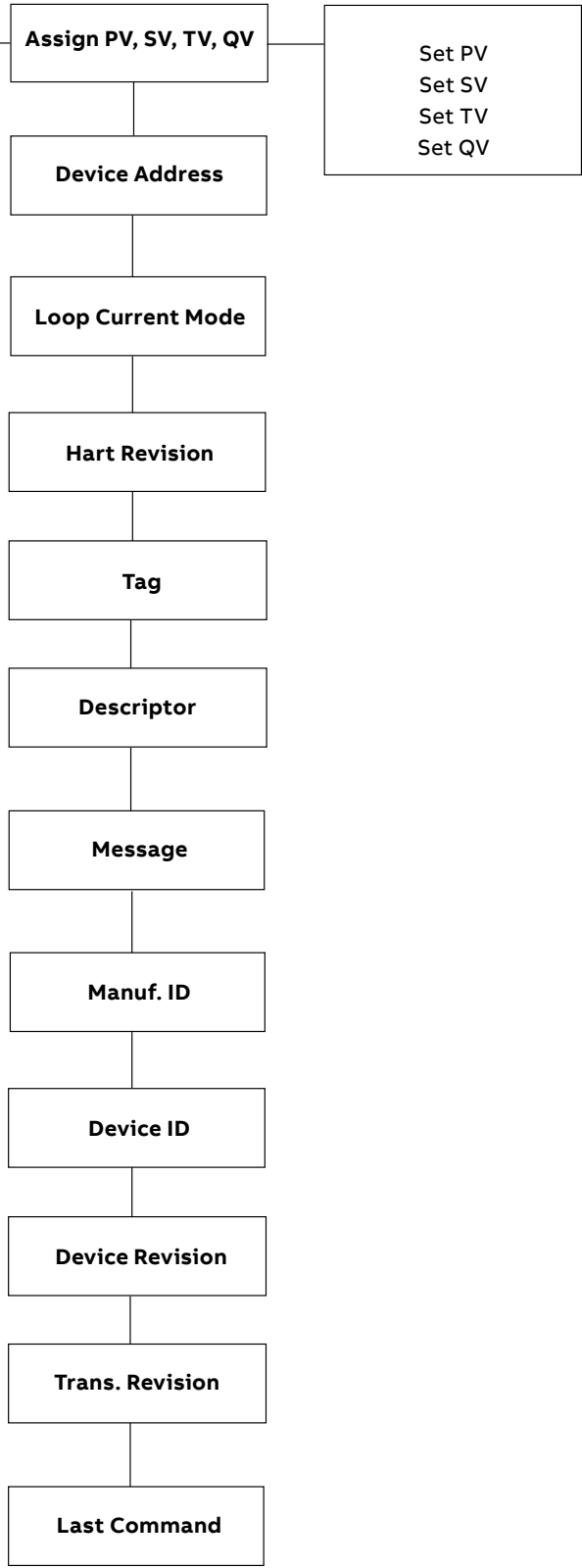





Menu: Communication (continued)

Menu/Parameter	Value Range	Description
Communication/Assign PV, SV, TV, QV	Level, Interface, Distance- Ullage, Temperature, Volume Level, Volume Interface, Flow	Set PV Set SV Set TV Set QV *Temperature is the only device variable that cannot be PV
Device Address	0-63	Hart address, zero is default
Communication/Loop Current Mode	4-20 mA Fixed Current Mode	Allows process variable defined current Locks current to 3.6 mA
Communication/Hart Revision		
Hart Revision	7	Allows certain commands to be used
Communication/Tag		
Tag	Alphanumeric	User defined
Communication/Descriptor		
Descriptor	Alphanumeric	User defined
Communication/Message		
Message	Alphanumeric	User defined
Communication/Manuf. ID		
Manuf Id	26	Manufacturer ID
Communication/Device ID		
Device ID	xxxxxx	6 byte value unique to each device
Communication/Device Revision		
Device Revision	Numeric	
Communication/Trans. Revision		
Trans Revision	Numeric	
Communication/Last Command		
Last Command	Numeric	

9 Troubleshooting

Error messages via HMI display and HART signal

In case of transmitter errors or malfunctioning, the HART signal (via DTM, EDDL) and HMI are capable of displaying specific error / fault messages to aid the user in identifying the problem and resolving it. In the case of an alarm, a message consisting of an icon and text displays at the bottom of the process display. Use the (1) key to call up the information level. Use the "Diagnostics" menu to bring up the error description with the corresponding help text. In the error description, the error number is displayed in the second line (M028.018). Two further lines are used to describe the error. The device status is divided into four groups. The message text beside the icon in the display provides information about where to look for the error. There are five areas: Electronics, Sensor, Configuration, Operating and Process.

Icon	Description
	Error / failure
	Functional check (for example, during simulation)
	Out of specification
	Maintenance required

Error states and alarms

The following represents the errors states / alarms the LMT Series transmitters can encounter along with the recovery action needed to correct the issue.

Error Message	Tx LCD Message	Possible Cause	Suggested Action	Tx Response
F218.023	Electronics NV Failure	Electronics memory is corrupted	The electronics must be replaced	Analog signal to alarm
F226.044	Current Output Failure	The output circuit could be broken or not correctly calibrated	A DAC (digital to output converter) trimming should be performed and if the error persists the communication board must be replaced	Analog signal to alarm
F228.039	Primary Current Uncertain	The D to A converter is not properly calibrated or trimmed.	A DAC (digital to output converter) trimming should be performed and if the error persists the communication board must be replaced	Analog signal to alarm
		The device is not properly configured	Check the device configuration	
F244.003	Safety Function Flow Failure	Calculation of safety function did not occur in the proper sequence	Restart the device. If the condition persists contact service for a replacement.	Analog signal to alarm
F246.041	Electronics RAM Failure	Electronics memory test failed Process data memory check failed (dynamic duplicated error)	Restart the device. If the condition persists contact service for a replacement.	Analog signal to alarm
F247.040	Electronics ROM Failure	Program memory test failed	Restart the device. If the condition persists contact service for a replacement.	Analog signal to alarm
F248.006	Self-test failure		Restart the device. If the condition persists contact service for a replacement.	Analog signal to alarm
C138.036	Data Simulation Warning	The Level Value produced in output is derived by the value simulated in input	Using a HART configurator (DTM - Hand held) place device back in normal operating mode (Remove input simulation)	No effect
C139.037	Alarm Simulation Warning	An alarm condition is being simulated by the device	Using a HART configurator (DTM - Hand held) place device back in normal operating mode (Remove input simulation)	Depends on alarm simulated

Error Message	Tx LCD Message	Possible Cause	Suggested Action	Tx Response
C220.038	Current Output in Fixed Mode	Output current is in fixed mode. This could be due to the device being used in multi-drop mode or a simulation.	Using a HART configurator (DTM - Hand held) place device back in normal operating mode (Remove input simulation)	Current set to fixed value
F210.042	NV Replace Error	The Electronics or the Sensor have been changed but the replacement operation has not been executed.	The replacement operation must be executed. Set the SW 1 of the electronics to position 1 to enable the replace mode. Set SW 2 accordingly depending on which component (Electronics or Sensor) has been replaced. Power cycle the device. Move the SW 1 of the electronics to position 0.	Analog signal to alarm
		The Electronics or the Sensor have been changed. The replacement has been enabled but with the wrong direction. (SW 2 = 0)	The replacement operation must be executed. Only the data of the electronics can be copied to the sensor. Set the SW 1 of the electronics to position 1 to enable the replace mode. Set SW 2 to New Sensor position 1. Power cycle the device. Move the SW 1 of the electronics to position 0. Change the replacement direction (if possible). The SW 1 is already set to Enable replace mode. Set SW 2 to New Sensor (1). Power cycle the device. Move the SW 1 of the electronics to position 0.	
M130.030	HMI Validation Test Failure	HMI failed validation test	Replace HMI	No effect
S222.033	Amb. Temp Out of Range	Ambient temperature too high or too low	Check ambient temperature	No effect
		Temperature compensation saturated high or low		
S238.032	Electronics Insuff Input Voltage	Power supply too high or too low	Check power supply voltage at the device terminal is at least 12 Vdc	No effect
F215.004	Level Sensor Out of Limits	Result of Level measurement is outside of the valid and expected range	Using a HART configurator (DTM - Hand held) or the local HMI, navigate to the Diagnostics -> Waveform display and confirm the quality of the signal. The signal peak should visibly cross the threshold line and should measure approximately 2 Volts. Contact ABB service for additional support or a replacement if the condition persists.	Analog signal to alarm
S044.034	Process Temperature Warning	Process temperature above or below warning limits	Check process conditions. The compatibility of level transmitter model and process conditions has to be checked. Probably a different transmitter type is required.	No effect
S046.035	Process Temperature Alarm	Process temperature above or below alarm limits	Check process conditions. The compatibility of level transmitter model and process conditions has to be checked. Probably a different transmitter type is required.	No effect
S096.005	Temperature Sensor Out of Limits	Result of temperature measurement above or below process range	Restart the device. If the condition persists contact service for a replacement. The compatibility of level transmitter model and process conditions has to be checked. Probably a different transmitter type is required.	No effect
S140.045	Process Media Warning	Process value above high limit or below low limit	Check process conditions and/or device configuration. The compatibility of level transmitter model and process conditions has to be checked. Probably a different transmitter type is required.	No effect
S146.046	Process Media Alarm	Process value above high high limit or below low low limit	Check process conditions and/or device configuration. The compatibility of level transmitter model and process conditions has to be checked. Probably a different transmitter type is required.	No effect
S1484.010	Level Sensor Out of Range	Primary sensor reading above or below range values	Check process conditions and /or device configuration. The compatibility of level transmitter model and process conditions has to be checked. Probably a different transmitter type is required.	No effect

Error Message	Tx LCD Message	Possible Cause	Suggested Action	Tx Response
S224.043	Primary Current Saturated	Current saturated high or low	Check process conditions and/or device configuration. The compatibility of level transmitter model and process conditions has to be checked. Probably a different transmitter type is required.	No effect
_156.025	Electronics NV Syncing	Write non-volatile command received from CB Non-volatile Storage in progress	Information only	No effect
C154.047	Sensor Config Warning	The Level sensor trim is set to a default value The Temperature trimming configuration is corrupted	Contact service to perform a factory level sensor trim	No effect
C200.019	Device Reset Required	Device change requires restart	Restart device	No effect
C211.018	Sensor Board NV Write Error	An attempt to save data to the sensor module has failed	Restart the device. If the condition persists contact service.	No effect
F098.001	Temperature Sensor Failure	A temperature measurement has resulted in a value outside of the operating range.	Restart the device. If the condition persists contact service for a replacement.	Analog signal to alarm
F194.031	Sensor Board Fault	An error occurred in the sensor module. Possible causes could be a failed component in the sensor electronics, a configuration error, or the sensor assembly.	Using a HART configurator (DTM - Hand held) or the local HMI, navigate to the Diagnostics -> Waveform display and confirm the quality of the signal. The signal peak should visibly cross the threshold line and should measure approximately 2 Volts. Contact ABB service for additional support or a replacement if the condition persists.	Analog signal to alarm
F196.020	Sensor Communication Failure	An error occurred in the communication between the sensor and electronics modules.	Restart the device. If the condition persists contact service for a replacement.	Analog signal to alarm
F198.000	Level Sensor Failure	An error occurred in the sensor module. Possible causes could be a failed component in the sensor electronics or an error changing the configuration.	Restart the device. If the condition persists contact service for a replacement.	Analog signal to alarm
F212.017	Sensor Board Memory Failure	Writing to the sensor non-volatile memory was not successful.	The sensor should be replaced as soon as possible.	Analog signal to alarm

10 Maintenance

The LMT Series of level transmitters operate normally without the need for periodic maintenance or inspection. If the transmitter meets or exceeds the requirements of the application, the transmitter can be expected to provide reliable level indication for a minimum of ten years.

If the LMT Series of level transmitters is being used as part of a Safety Implemented System (SIS), periodic testing is required to proof the transmitter and detect any potential failure, which is defined as Dangerous-Undetectable in normal operation. This testing must be performed at regular intervals (2 years), and the results of this testing must be documented. Should the transmitter exhibit a fault during normal operation, it is necessary to perform the proof testing, regardless of the schedule. As part of the testing documentation, all parameters included in the menu structure of the transmitter, as well as the configuration of the module jumpers, must be recorded. As devices, the LMT Series is used to provide a level measurement to prevent overflow and dry run of a vessel.

If a transmitter fails an inspection or assistance is required for inspection or troubleshooting, contact the ABB Service Department via email at ktek-service@us.abb.com. The Service Department will answer questions, provide additional assistance and issue Return Authorization Numbers for equipment in need of repair.

⚠ CAUTION

In the event a magnetostrictive transmitter has suffered a failure in any component which is exposed to the process, any other magnetostrictive transmitter installed in the same or similar process should be inspected for the same failure, regardless of its maintenance schedule. These common cause failures include: 1) float collapse due to over pressure; 2) damage due to material incompatibility; 3) damage of the sensor tube due to improper installation.

Personnel qualifications

Safety inspection, maintenance and troubleshooting should only be performed by qualified personnel. These qualifications include knowledge of information in this instruction manual, knowledge of the product and its operating principles, knowledge of the application in which the transmitter is being applied and general experience as an instrument technician.

Before, during and after performing a safety inspection, maintenance or troubleshooting, it is necessary to observe and adhere to any safety standards, practices or requirements defined in the end user policies.

Required tools

The following tools may be required to perform inspection, maintenance or troubleshooting for the LMT Series of level transmitters.

- Crescent wrench
- Screwdrivers
- Hex key wrenches
- Digital multi-meter
- Measuring tape
- Proprietary cable (purchased from ABB) for updating electronic and sensor firmware (optional).

Electronic replacement

If the electronic module needs to be replaced proceed as follows:

- 1 Disconnect the power supply and disconnect the wiring.

⚠ DANGER - Serious damage to health / risk to life

Explosion hazard. Do not open or disconnect equipment when a flammable or combustible atmosphere is present.

- 2 Open the communication board compartment cover.



Figure 38 Open Housing Cover

- 3 Remove the HMI display (if installed)



Figure 39 HMI Display

- 4 The removable male header connecting the HMI board to the Communication Board may be removed and shall be put back during the reassembly process.

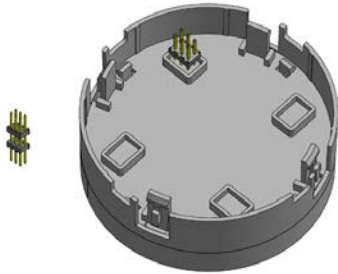

Figure 40 HMI Connector Pin

NOTICE – Property damage

Failure to disconnect the power supply could result in damage while removing the communication board electronics

- 5 Unscrew the communication board and gently disconnect the connector on back of the board



Figure 41 Communication Board

- 6 Connect the sensor flat cable to the new electronic module with dip switch 1 in up position.
- 7 Screw the new communication into the housing.
- 8 Connect the transmitter to power supply, wait ten seconds and lower dip-switch 1 to 0 position. LMT can reconfigure itself with the previous configured parameters thanks to the auto-configuration functionality.
- 9 Reset the dip switch position
- 10 Connect back the HMI board on top the communication board with the double male header connector removed in step 3.
- 11 Place back the window cover removed during step 2.

Safety Inspection and Test

An LMT Series transmitter can be divided up into four major components the float, the sensor, the transmitter and the output. All of these components and their subcomponents should be evaluated during each periodic inspection. This inspection (and possible repair) should take less than 4 hours if the proper tools are made available. Prior to inspection, the transmitter should be removed from service following end user specified procedures regarding lockout, tagout, wiring and cleaning. Once removed from service, the LMT Series transmitter should be laid on a flat even surface. For detailed safety guidelines, refer to the LMT Series Safety Manual (SM LMT100200- EN A)

Float inspection

The LMT Series will detect and report the position of the float on its sensor tube as a level of fluid in the process. In order to measure the fluid in the process properly, the float must move freely up and down the sensor tube partially submerged in the liquid level. If the float were to become damaged or stuck on the sensor tube, the transmitter will still report the float position regardless of the actual process fluid level. This by definition is a Dangerous Undetectable failure. To prevent this failure the float will need to be inspected for integrity and movement. Some transmitters will have two floats mounted on the sensor tube. This inspection should be done on both floats.

- 1 Move the float up and down the length of the sensor tube. It should move freely from the bottom of the sensor tube to the process connection.
- 2 Remove the float from the sensor tube by removing the retaining clip or bolt from the end of the transmitter. Inspect the float for signs of excessive wear or damage.
- 3 Submerge the float in a container of water to check for leaks as air bubbles escaping from the float. The float is a sealed unit and any holes in the shell of the float could allow process fluid to seep inside.

IMPORTANT NOTE

ABB floats are designed for different specific gravity ranges. The float may or may not float in the water. It may be necessary to hold the float under the water to perform this test.

Upon completion of float inspection, place the float back on the sensor tube paying careful attention to float orientation. Some LMT Series transmitters will be equipped with float spacers designed to keep the float positioned in the measurable range of the sensor tube. It is important that the spacer be replaced when the transmitter is reassembled.

IMPORTANT NOTE

When handling the transmitter ensure the probe does not bend during installation. A bend in the probe could prevent the float from travelling freely up and down and it could damage the magnetostrictive wire fitted inside.

Sensor inspection

The sensor of the LMT Series consists of a metal tube containing several wires. The sensor tube will measure the float location properly if the tube is straight and the float can travel freely up and down its length. Perform a visual inspection on the sensor tube to make sure it is straight, free from pits or gouges, and does not show excessive wear patterns.

Transmitter testing

The transmitter of the LMT Series is designed to return a level indication and an output based on the position of a float on its sensor tube. If the transmitter is equipped with an HMI, the level and output will be displayed on the front of the electronics module.

- 1 Apply power to the transmitter using the typical power setup for the particular option.
- 2 Move the float up and down the sensor tube.
- 3 Monitor the indication of the level on the HMI to make sure the indication corresponds to the float position.
- 4 Remove the float to make sure the transmitter responds with an Alarm Indication (based on the dip switch position) and a level indication of ----.
- 5 Place the float back on the sensor tube with the correct orientation.

IMPORTANT NOTE

It is possible for the LMT Series to continue providing a 4-20 mA output if the HMI display is not functioning properly. If the HMI indicator on an electronics module fails to operate, it is recommended that the electronics module be replaced at the earliest convenience. It will not be necessary however to shut down a transmitter or remove it from service based on an HMI failure.

Output Checkout

The LMT Series is equipped to provide level indication through the 4-20 mA output with HART communications. Only transmitters that are specified to output 4-20 mA may be used in a Safety Implemented System. The HART communication capability of the 4-20 mA transmitter will only be used for configuration and proof testing.

4-20 mA Output

The current output of the LMT Series transmitter update at least every 110 milliseconds and be filtered through the user adjusted Damping. The maximum response time to a process change will be less than 110 milliseconds or the value of the Damping, whichever is greater.

- 1 Apply power to the transmitter using the typical loop wiring.
- 2 Connect a multi-meter (set to read milliamps) to the transmitter using the "Meter" connections on the terminal strip.
- 3 Move the float along the length of the probe and monitor the milliamp output on multi-meter .

- 4 The output should indicate the float position based on the calibration range of the transmitter.

HART Output

- 1 Apply power to the transmitter using the typical loop wiring.
- 2 Connect a HART handheld device across a 250 ohm resistor in series with the loop.
- 3 Move the float along the length of the probe and monitor the PV indication on the handheld device.
- 4 The output should indicate the float position based on the calibration range of the transmitter.

Loop Check

- Without HART

With the transmitter installed, wired and powered in its field location, move the float up and down the length of the probe. Confirm the proper reading at the indication or control side of the loop. Move the float using the process fluid or some other mechanical means. If moving the float is not possible, the loop may be checked using an independent device such as a loop calibrator.

- With HART communications

With the transmitter installed, wired and powered in its field location and power supplied to the loop, connect a HART handheld device to the loop across a 250 ohm resistor. Using the Loop Test feature of the HART handheld, drive the output of the transmitter to 4 mA and 20 mA. Confirm the proper reading at the indication or control side of the loop. Minor adjustments to the output of the transmitter may be made using the DAC Trim (Digital/Analog Convertor) feature.

Spare parts

Please refer to Figure 3 in this manual for the item in the below spare part list table.

Item no.	Description	Part Number
1	Window cover - aluminum	3KQZ207029U0100
	Window cover - stainless steel	3KQZ207030U0100
2	HMI display assembly	3KQZ204001U0000
3	HMI connector	3KXL000273U0100
4	Communication board	3KQZ207044U0300
	Terminal board without surge	3KQZ207063U0100
6	Terminal board with surge	3KQZ207064U0100
	Blind cover - aluminum	3KQZ207035U0100
7	Blind cover - stainless steel	3KQZ207110U0100
	Agency approved plug (½" NPT)	3KXL000613U2600
8	Agency approved plug (M20)	3KXL000614U1100
	Plastic plug (½" NPT)	3KXL000438U0100
9	Plastic plug (M20)	3KXL000289U0100
	Standard mounting kit	SPM200-1018-3
12	Vibration isolator mounting kit	VI-KIT

11 Dimensional drawings

Enclosures

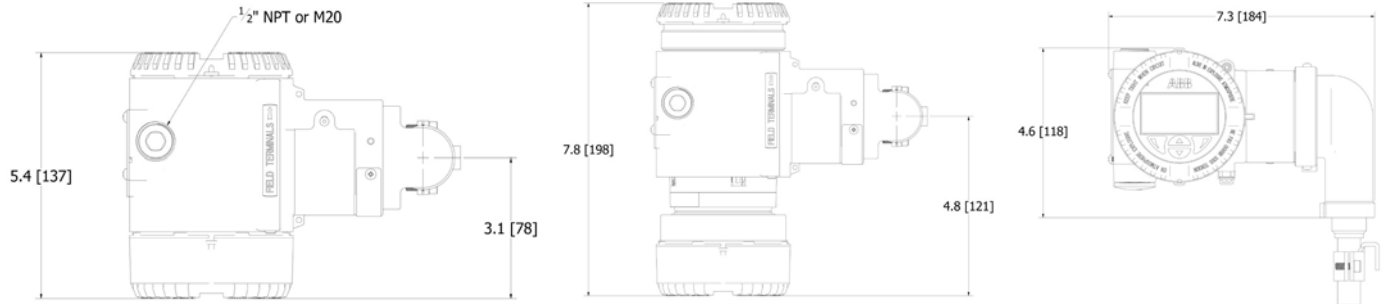

*Drawings for Reference Only

LMT100 PROBE TYPE R1, C1 and H1

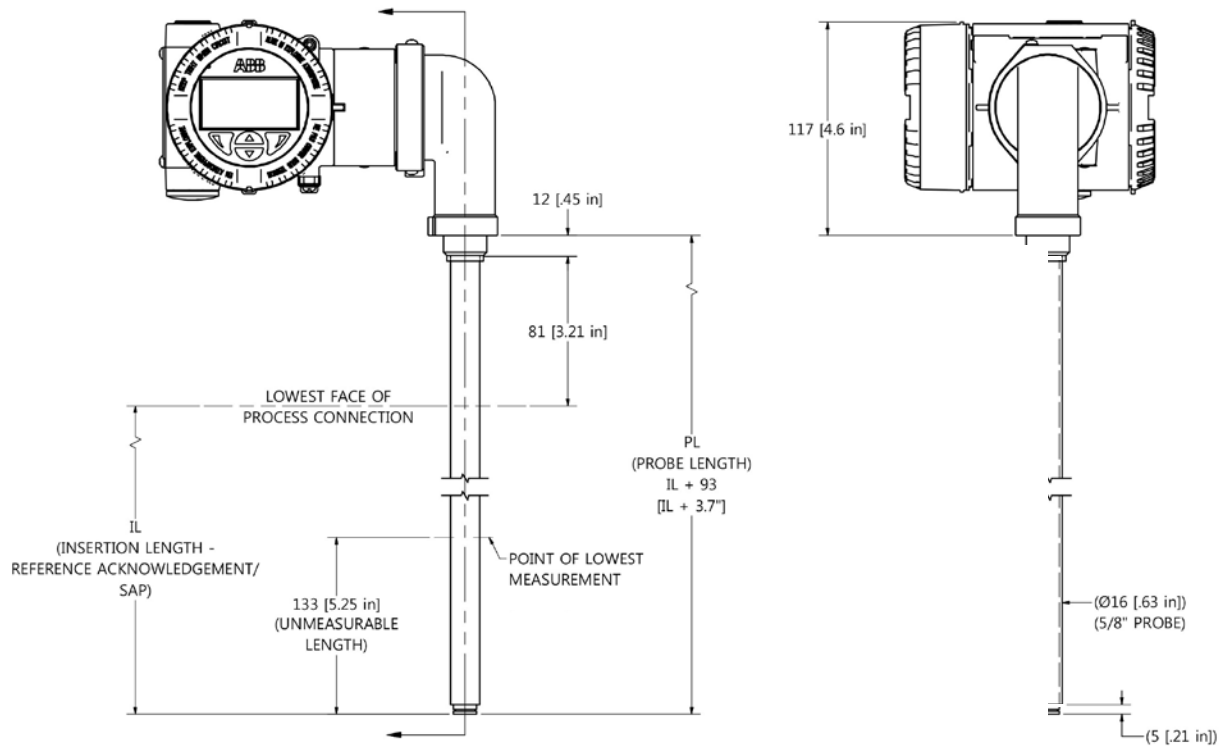

*Drawings for Reference Only

LMT100 PROBE TYPE R2, R3, C2 and H2

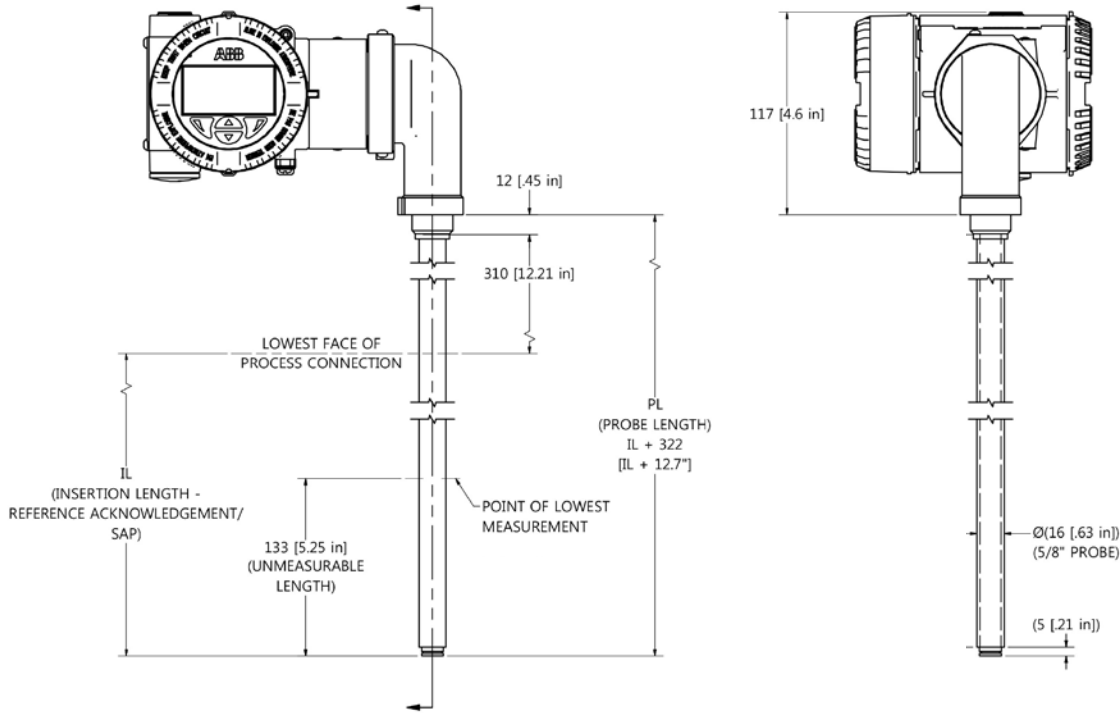

*Drawings for Reference Only

LMT100 PROBE TYPE R4

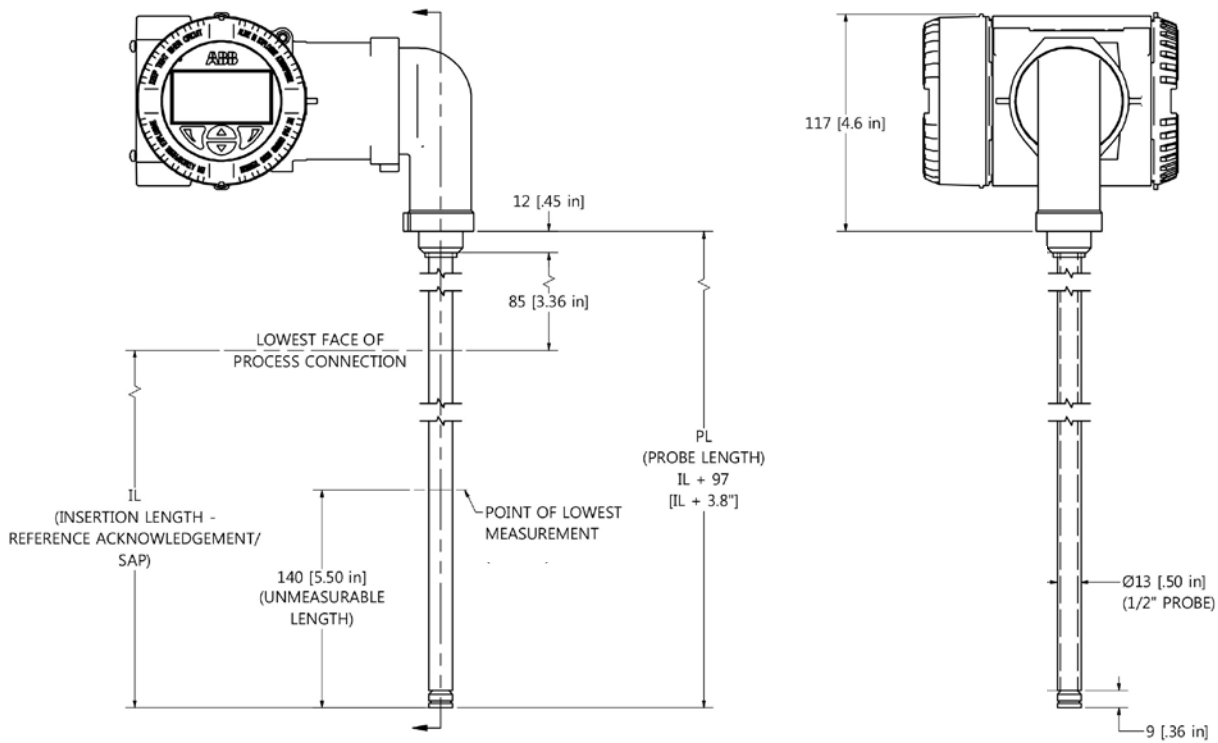

*Drawings for Reference Only

LMT100 PROBE TYPE R5

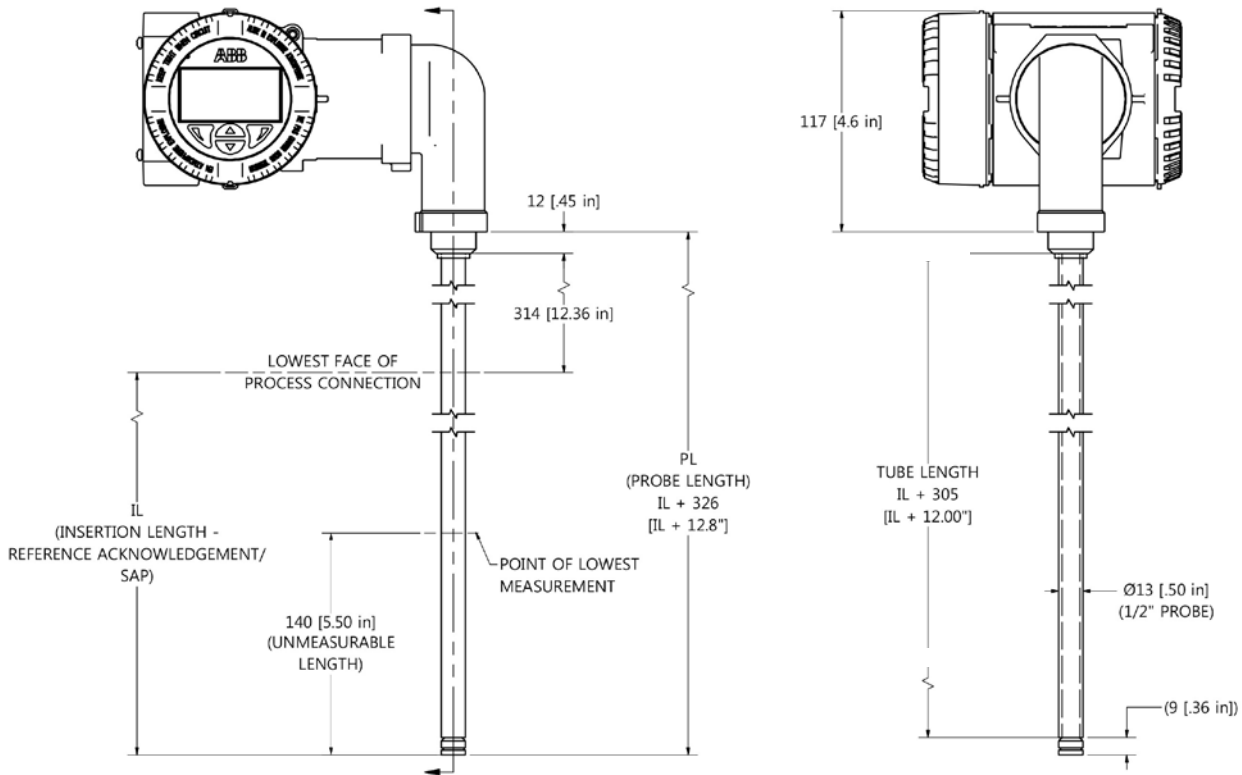

*Drawings for Reference Only

LMT100, PROBE TYPE W1

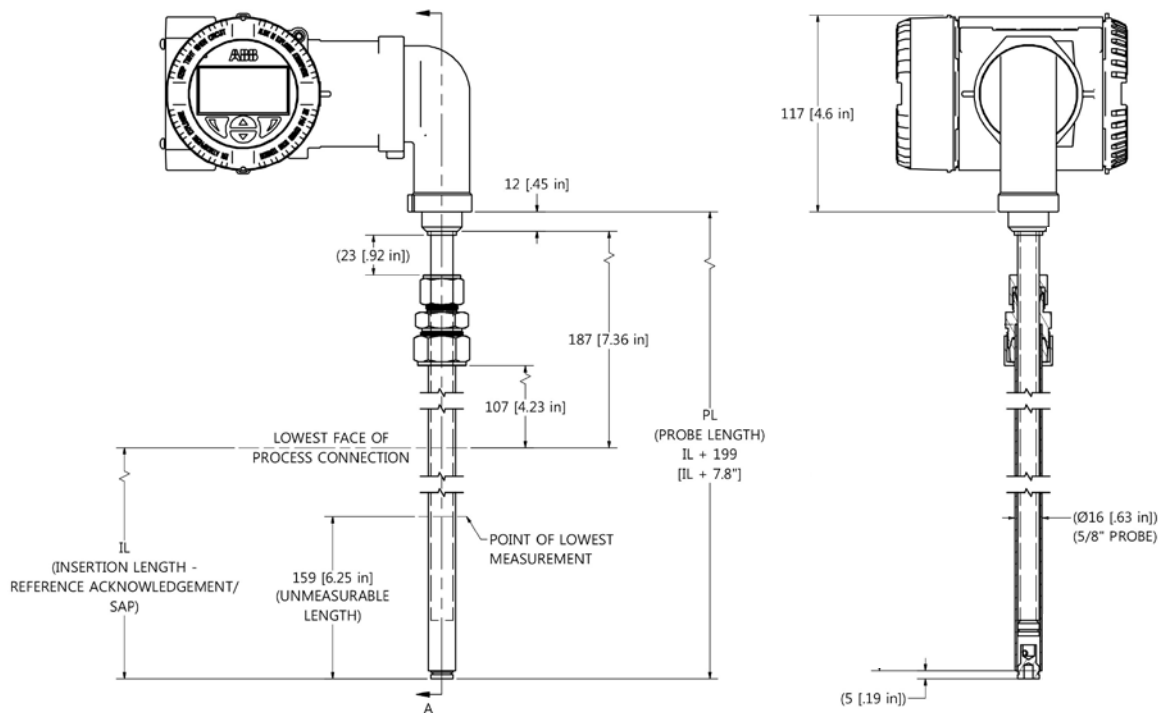

*Drawings for Reference Only

LMT100 PROBE TYPE W2

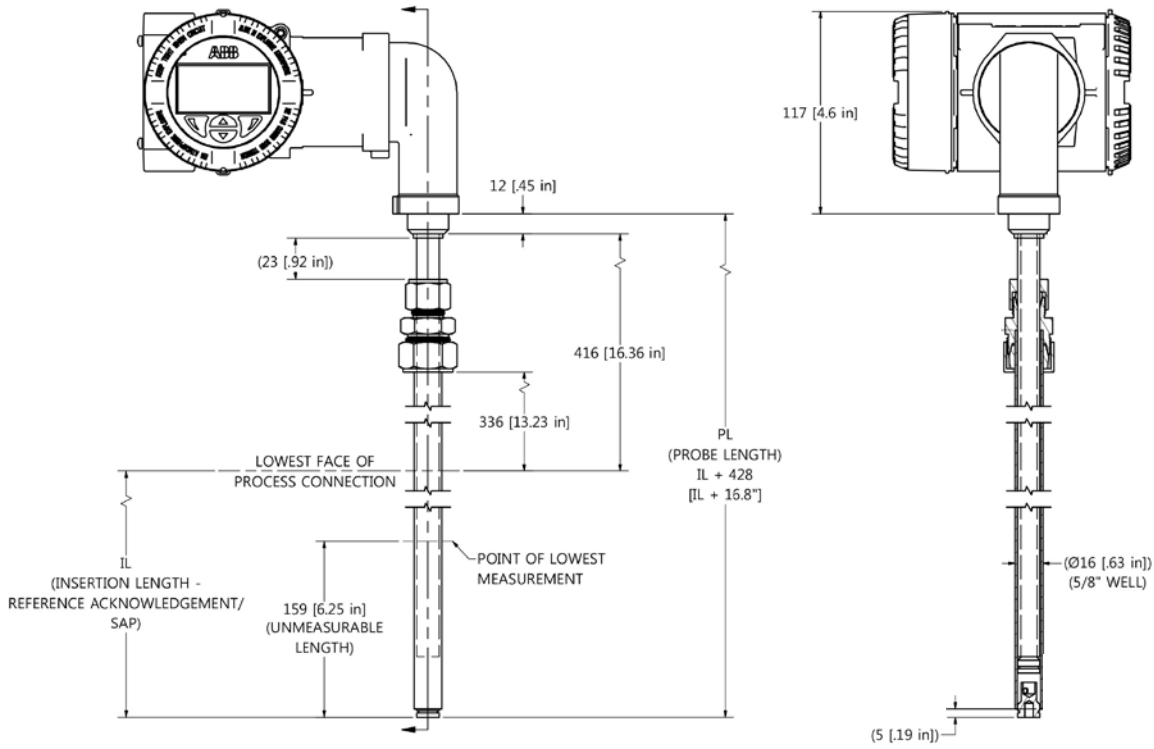

*Drawings for Reference Only

LMT100 PROBE TYPE C3, W4

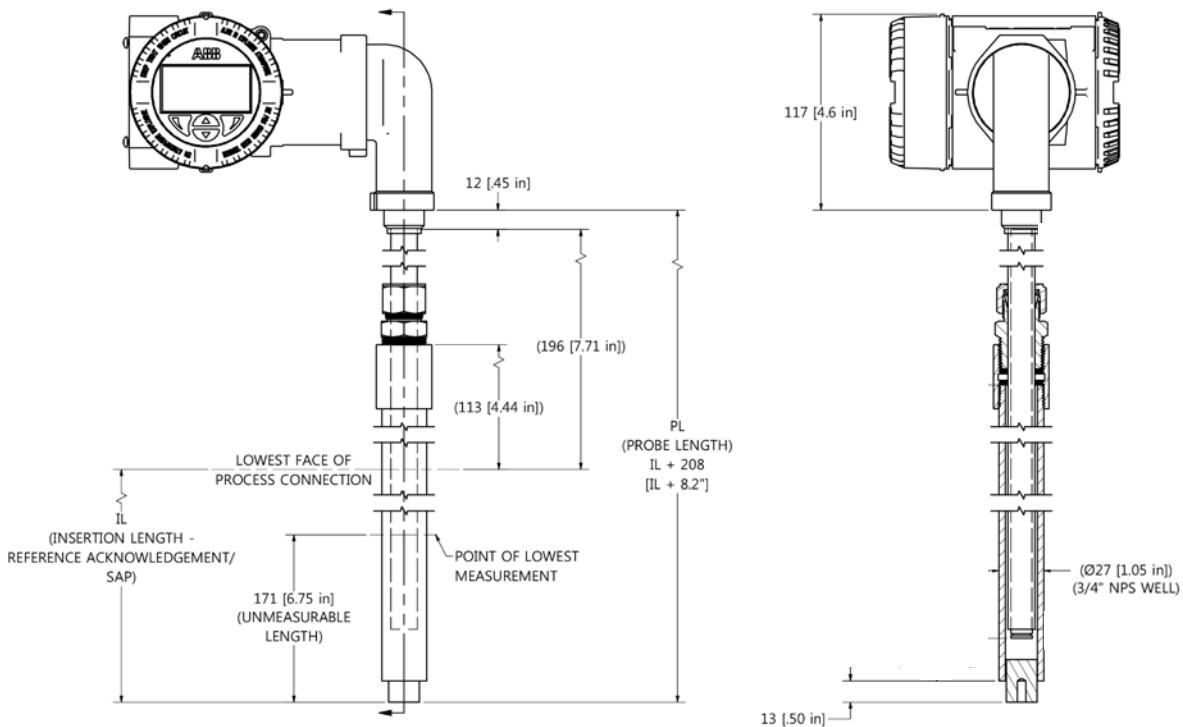

*Drawings for Reference Only

LMT100, PROBE TYPE C4, W5 and W6

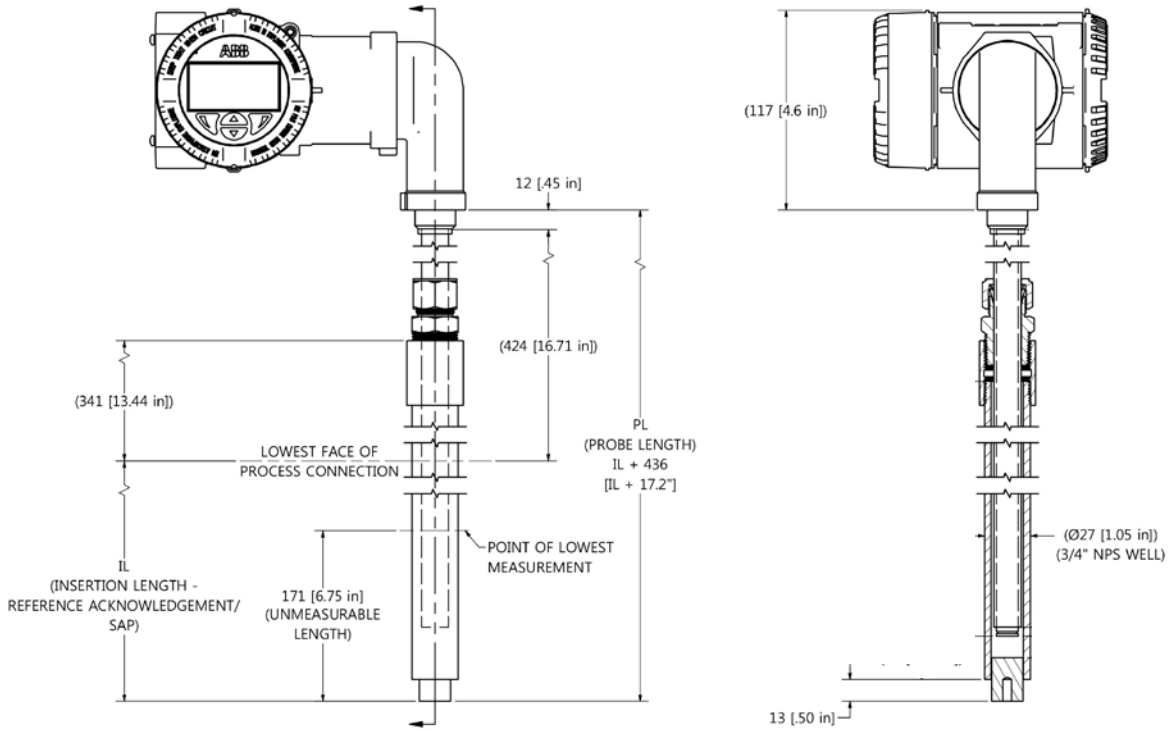

*Drawings for Reference Only

LMT100 PROBE TYPE J1

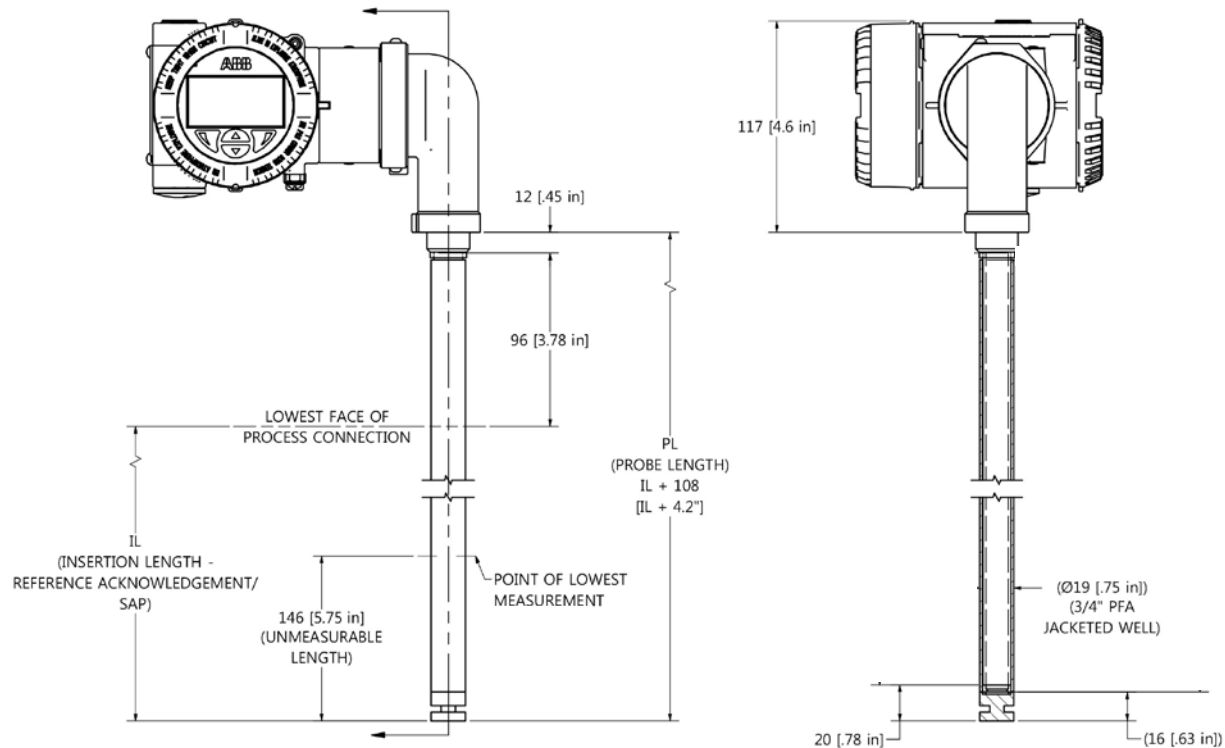

*Drawings for Reference Only

LMT100 PROBE TYPE J2

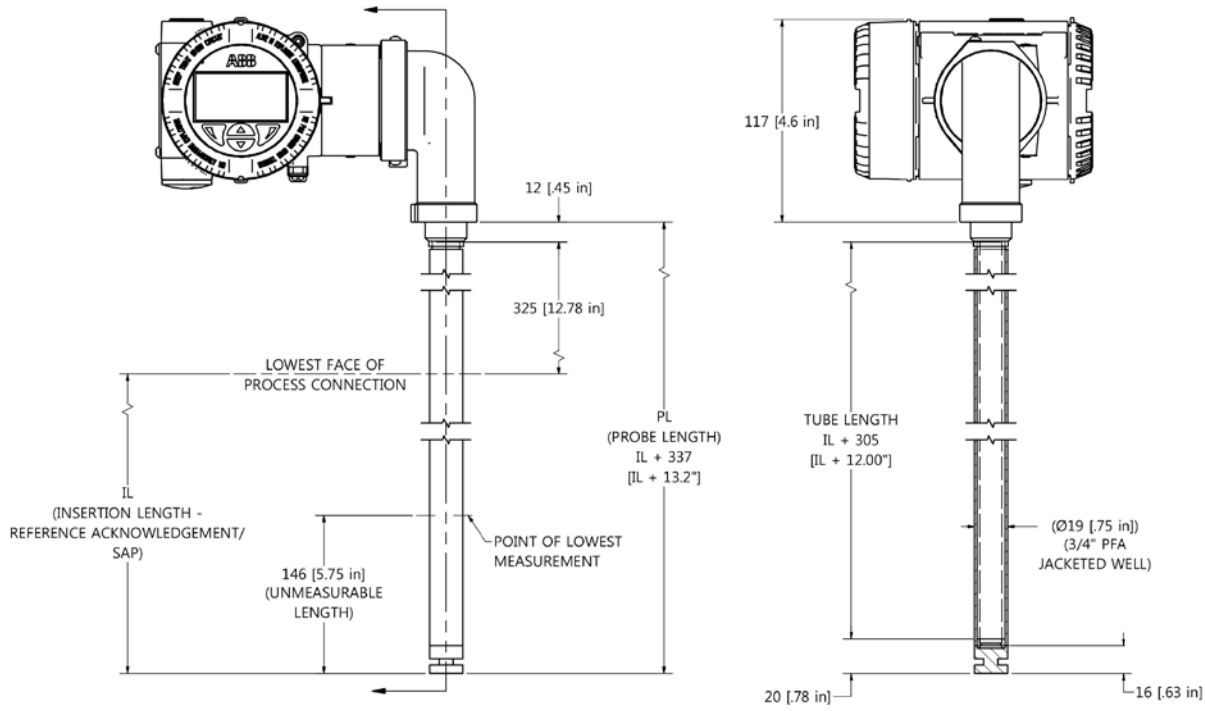

*Drawings for Reference Only

LMT100 PROBE TYPE J4 and J5

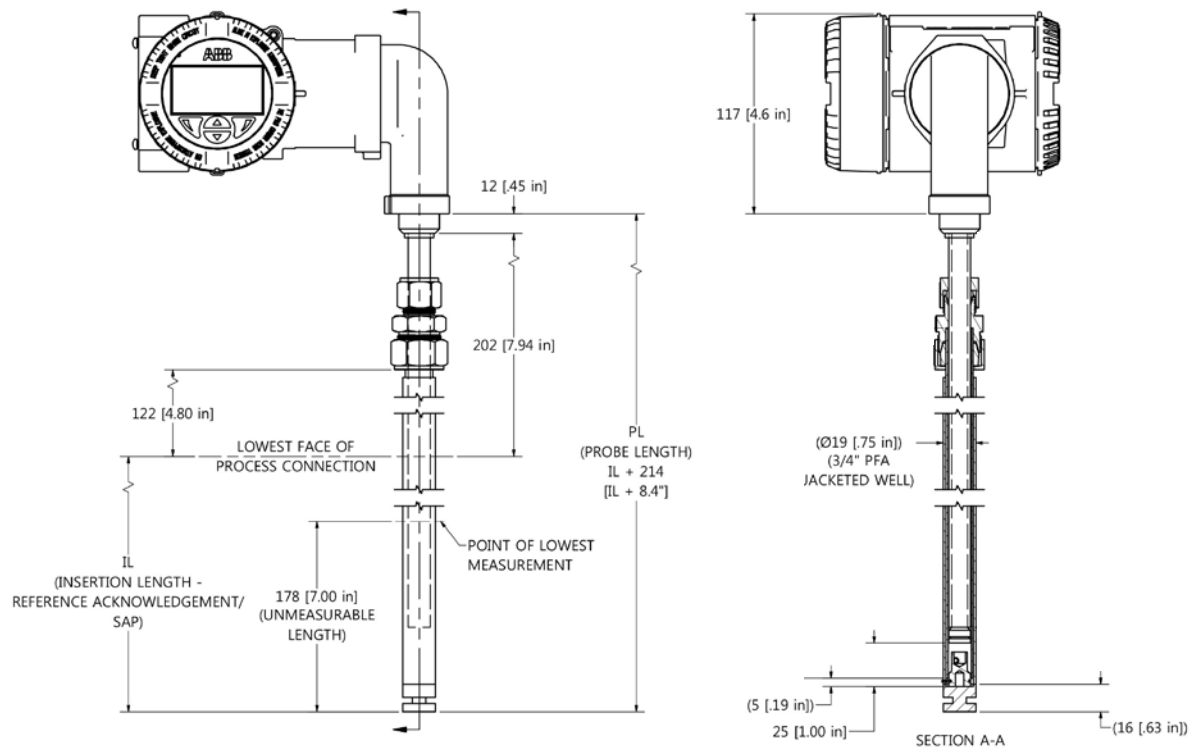

*Drawings for Reference Only

LMT100 PROBE TYPE W3

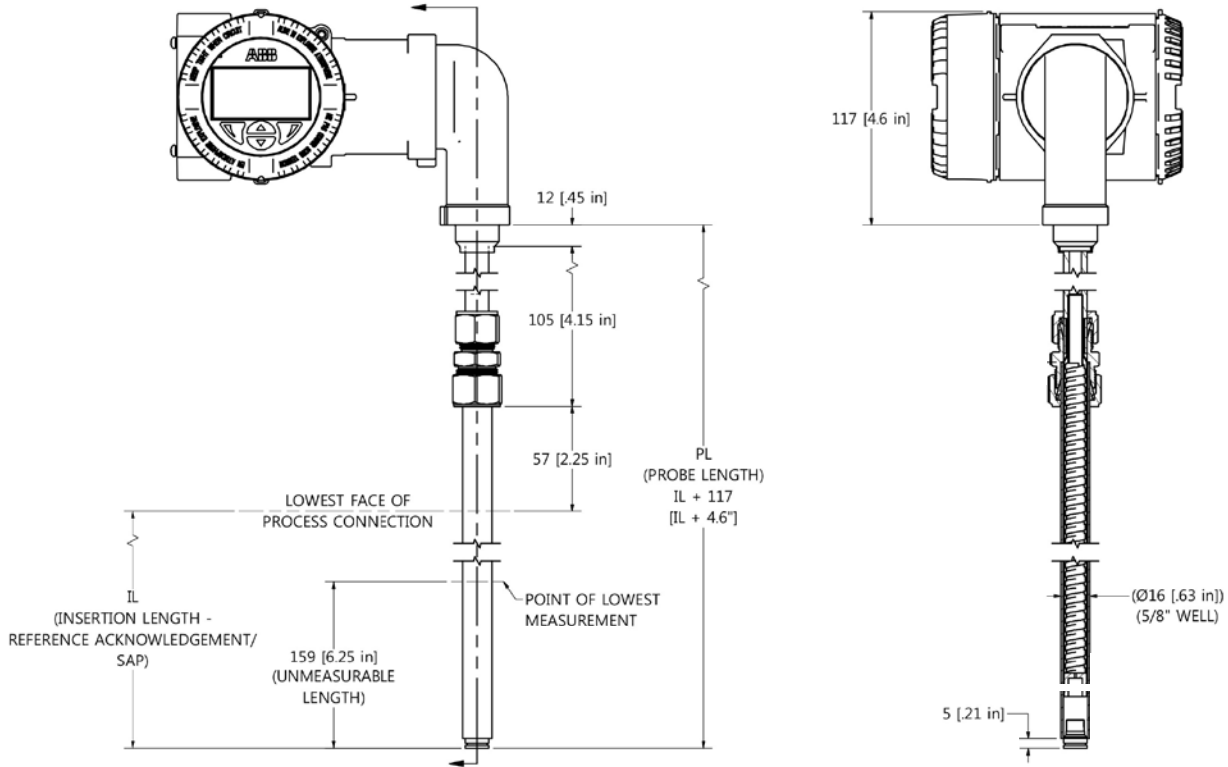

*Drawings for Reference Only

LMT100 W3 Well with Probe

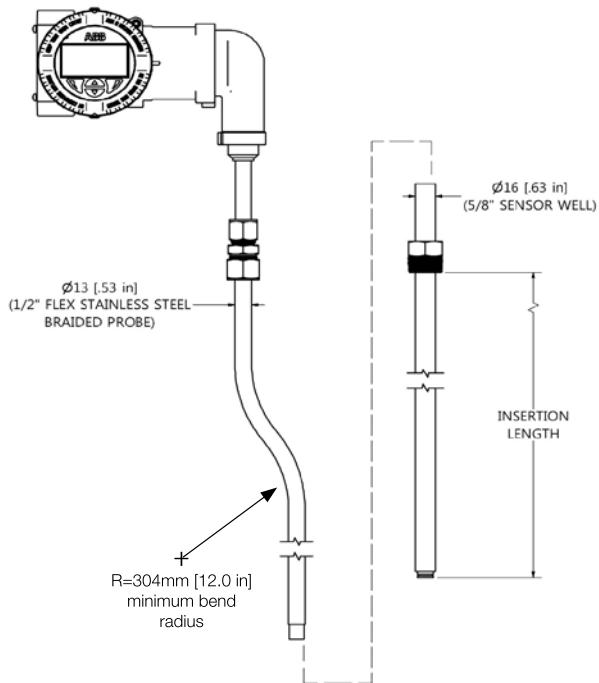

*Drawings for Reference Only

LMT100 PROBE TYPE W7

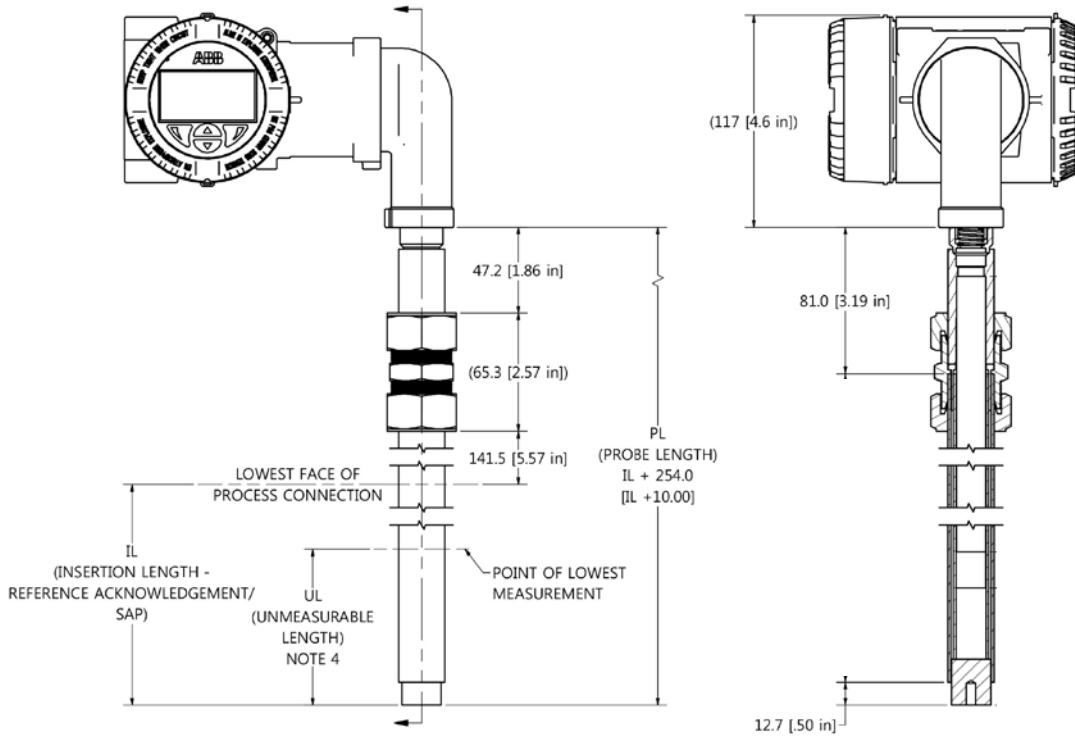

*Drawings for Reference Only

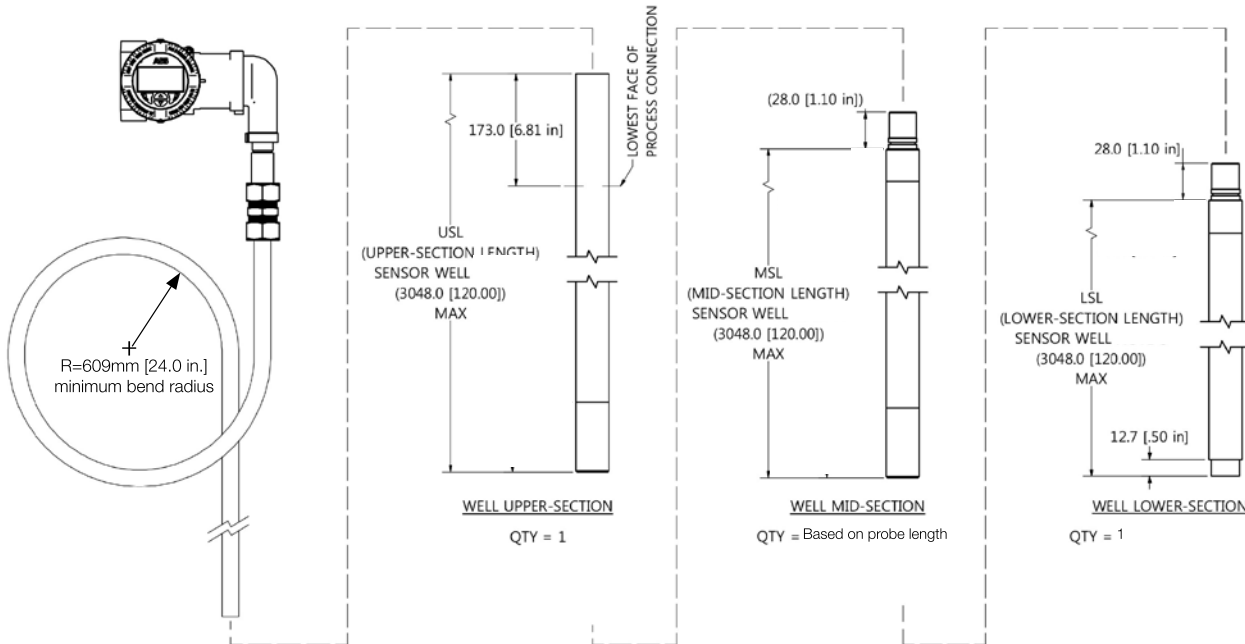

*Drawings for Reference Only

LMT200 Probe Type R1, R2 & R3 - Top Mount

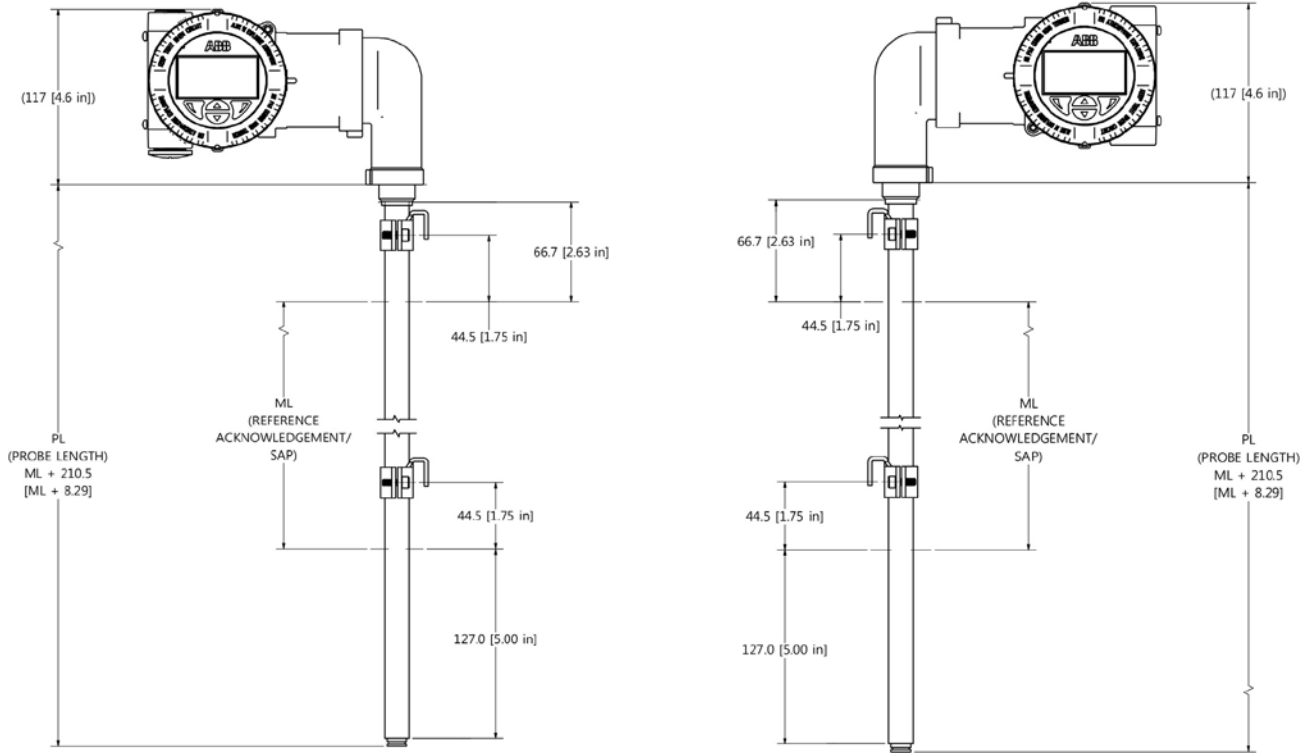

*Drawings for Reference Only

LMT200 Probe Type R1, R2 & R3 - Bottom Mount

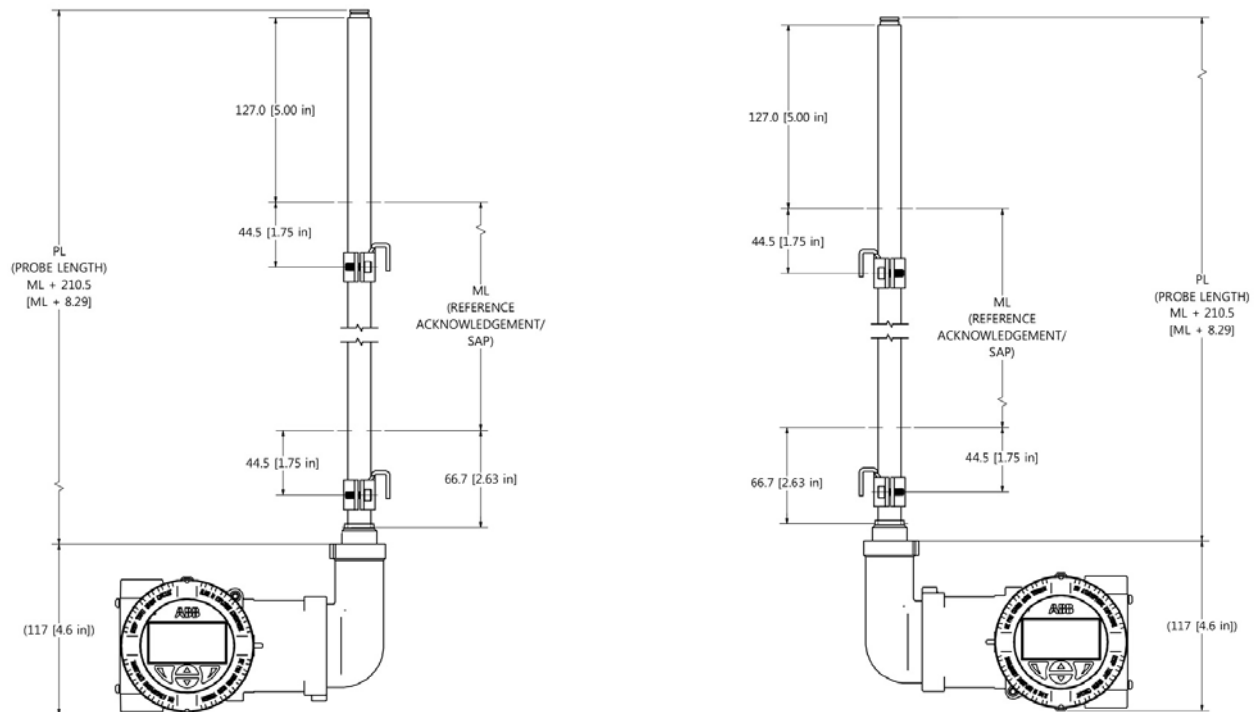

*Drawings for Reference Only

LMT200 SEH 90 degree bend housing extension - Top Mount

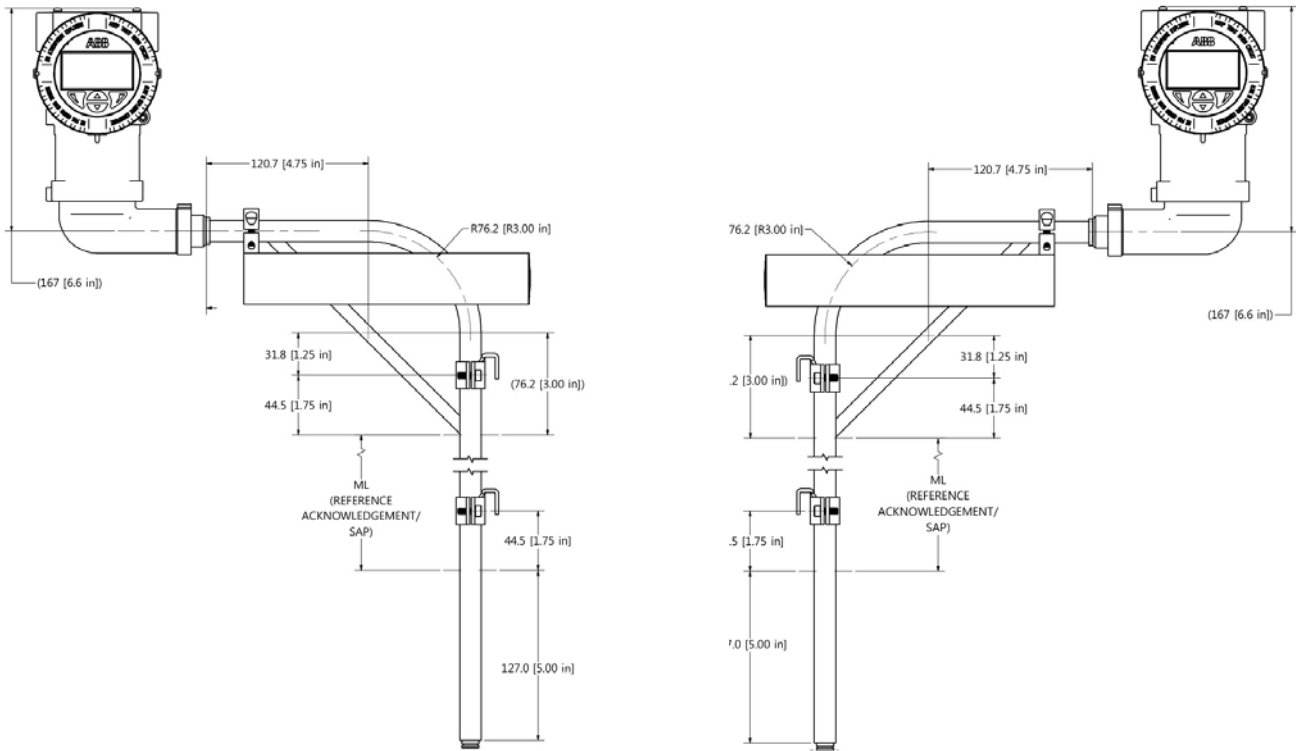

*Drawings for Reference Only

LMT200 SEH 90 degree bend housing extension - Bottom Mount

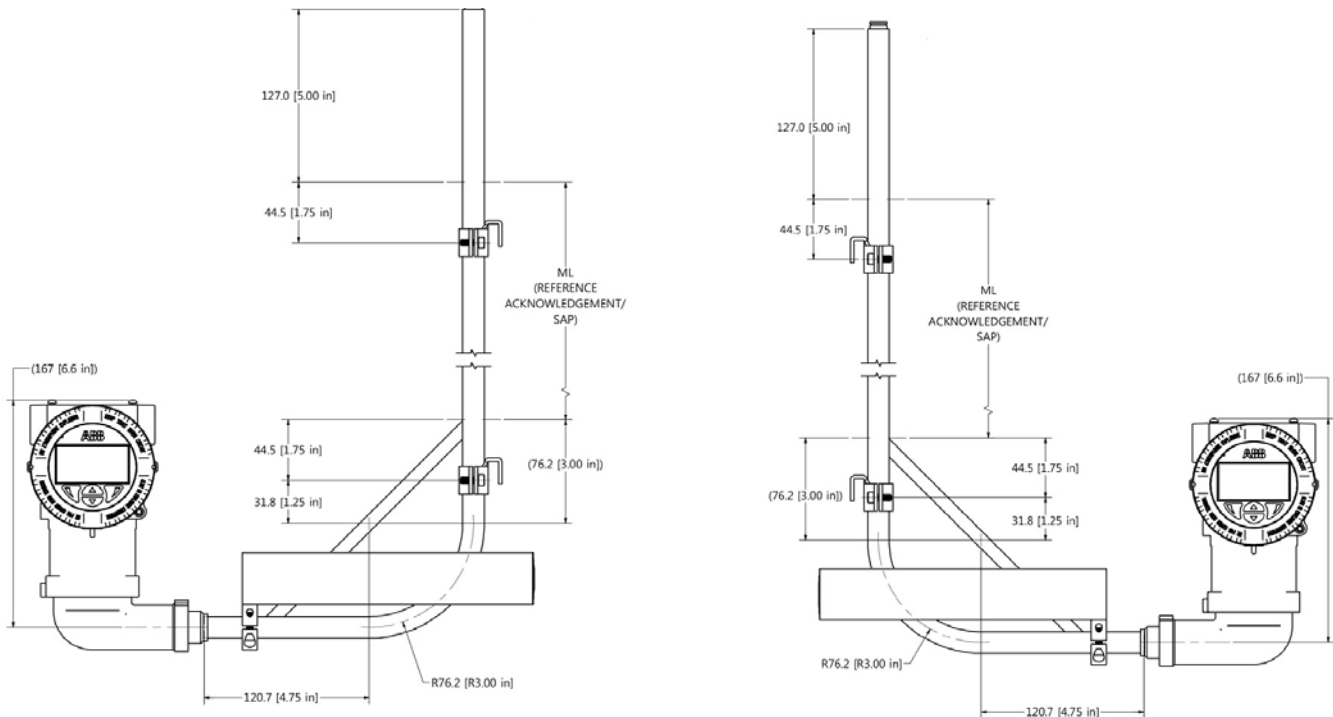

*Drawings for Reference Only

LMT200 Cryogenic with insertion well - Top Mount

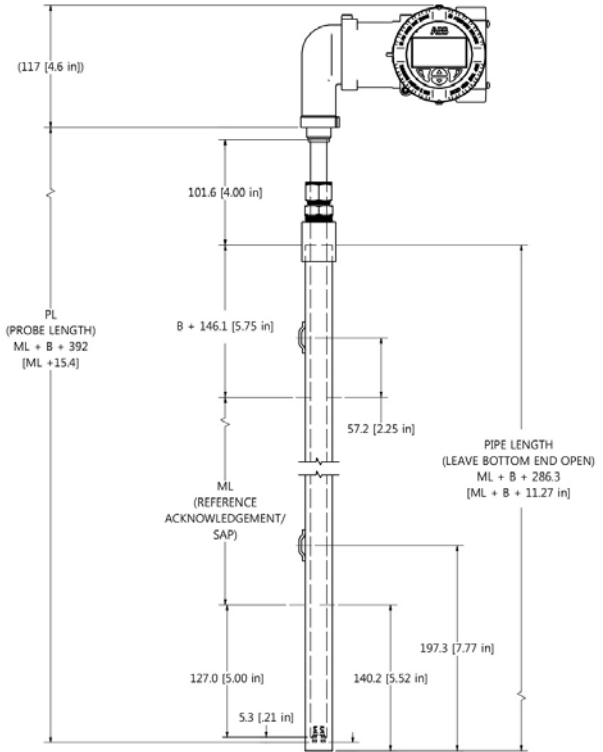
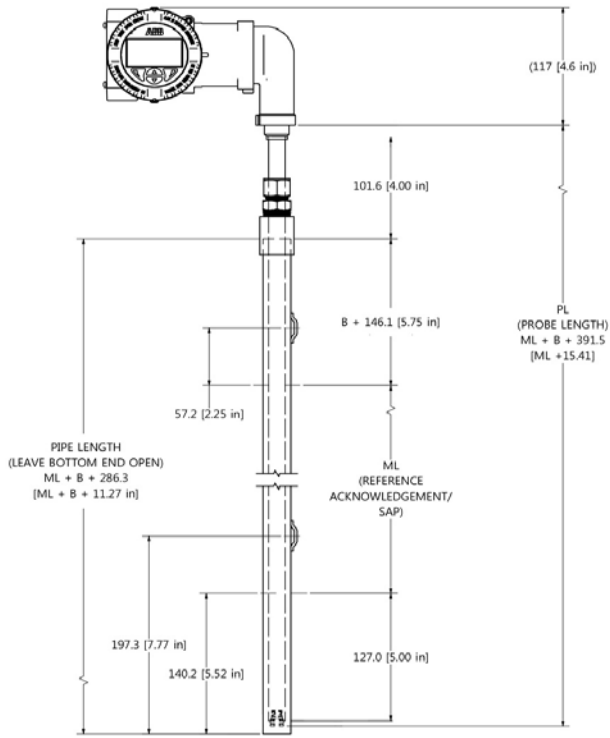

*Drawings for Reference Only

Vibration Isolator Mount Option

Kit Includes:

- 1 Vibration Isolator
- 1 Chamber mounting clamp assembly
- 2 Bearing clamp assemblies

For measurement lengths (ML) of 914.4 mm (36 in) or less, a minimum of two VIKIT assemblies are recommended for installation in high vibration applications.

For ML greater than 914.4 mm (36 in), the number of isolators required can be determined from the below chart.

ML up to	# of Kits
914.4 mm (36 in)	2
1828.8 mm (72 in)	3
2286.0 mm (90 in)	4
2743.2 mm (108 in)	4
3200.4 mm (126 in)	5
3657.6 mm (144 in)	5
4114.8 mm (162 in)	6
4572.0 mm (180 in)	6
> 4572.0 mm (180 in)	consult factory



Position Transmitter Mounting Option

Example Installation: LMT200 Valve Position Transmitter and Hydraulic Control Valve

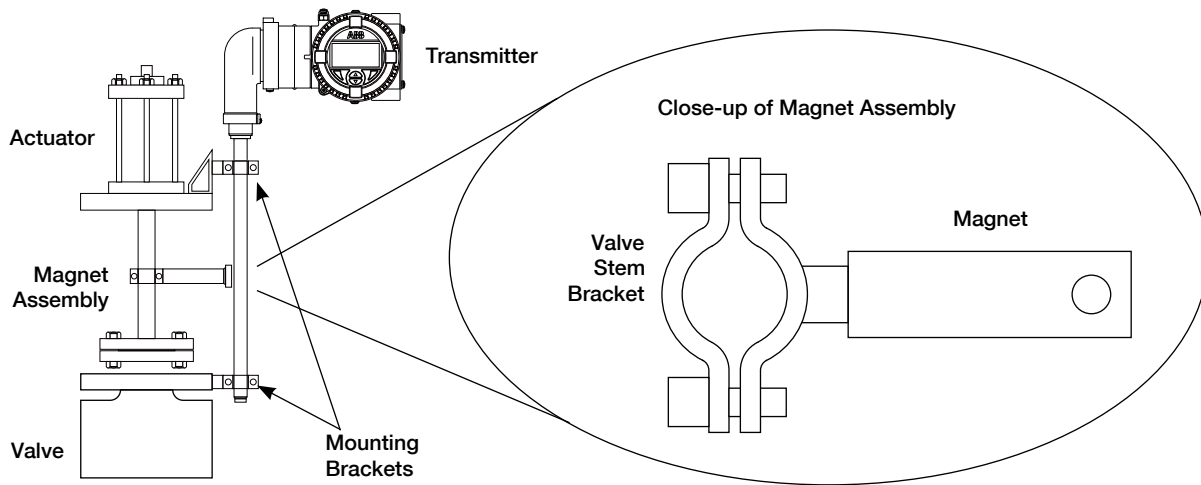

12 ABB RMA Form



ABB, Inc
 Industrial Automation
 125 E. County Line Road
 Warminster, PA 18974 USA
 Tel: +1 215 674 6000
 Fax: +1 215 674 7183
 Service email: ktek-service@us.abb.com

*** IMPORTANT CUSTOMER NOTICE: PLEASE READ PRIOR TO RETURNING PRODUCTS TO ABB***

Be sure to include the Return Authorization (RA) number on the shipping label or package to the attention: Customer Service. A copy of this document should also be included with the packing list. ABB wants to maintain a safe work environment for its employees. In the event, the returned product or material has been in contact with a potentially hazardous chemical, per federal regulations, the customer must provide evidence of decontamination and the related chemical composition and characteristics. In order to expedite your return, please include the applicable Material Safety Data Sheets (MSDS) and decontamination tags by affixing these documents in close proximity to the shipment label for identification purposes. (January 18, 2006)

Return Authorization Form

Customer:	Date:
Contact Name:	Product:
Contact Email:	Serial No:
Contact Phone:	Job No:
Contact Fax:	Service Rep:

Completed by Customer

Reason

Problem Found:

Action:

Requested:

Is expedited return shipping requested? Yes No

If yes, please provide a purchase order or your shipper's account number (ex. FedEx or UPS). ABB pays return transport via standard ground shipments only.

If purchase order is issued, a copy of purchase order must be included with return documentation.

Is ABB authorized to repair items determined to be non-warranty? Yes No

If yes, a copy of purchase order must be included with return documentation.

Has product been in contact with any potentially hazardous chemical? Yes No

If yes, documentation product and forward MSDS to ABB, "ATTN: Customer Service"

Return Repaired Product to Address

Shipping Address:

Billing Address:

Notes

Notes

ABB Inc.

Industrial Automation
125 E. County Line Road
Warminster, PA 18974 USA
Tel: +1 215 674 6000
Fax: +1 215 674 7183

ABB Engineering (Shanghai) Ltd.

No. 4528, KangXin Hwy.
Pudong New District
Shanghai, 201319, P.R. China
Phone: +86 10 64231407
Service: +86 4008209696
E-mail: sales-support.kq@cn.abb.com
Service e-mail: instrumentservice.abbchina@cn.abb.com

www.abb.com/level

We reserve the right to make technical changes or modify the contents of this document without prior notice. With regard to purchase orders, the agreed particulars shall prevail. ABB does not accept any responsibility whatsoever for potential errors or possible lack of information in this document.

We reserve all rights in this document and in the subject matter and illustrations contained therein. Any reproduction, disclosure to third parties or utilization of its contents - in whole or in parts - is forbidden without prior written consent of ABB.

Copyright© 2018 ABB All rights reserved

3KXL141000R4201

